

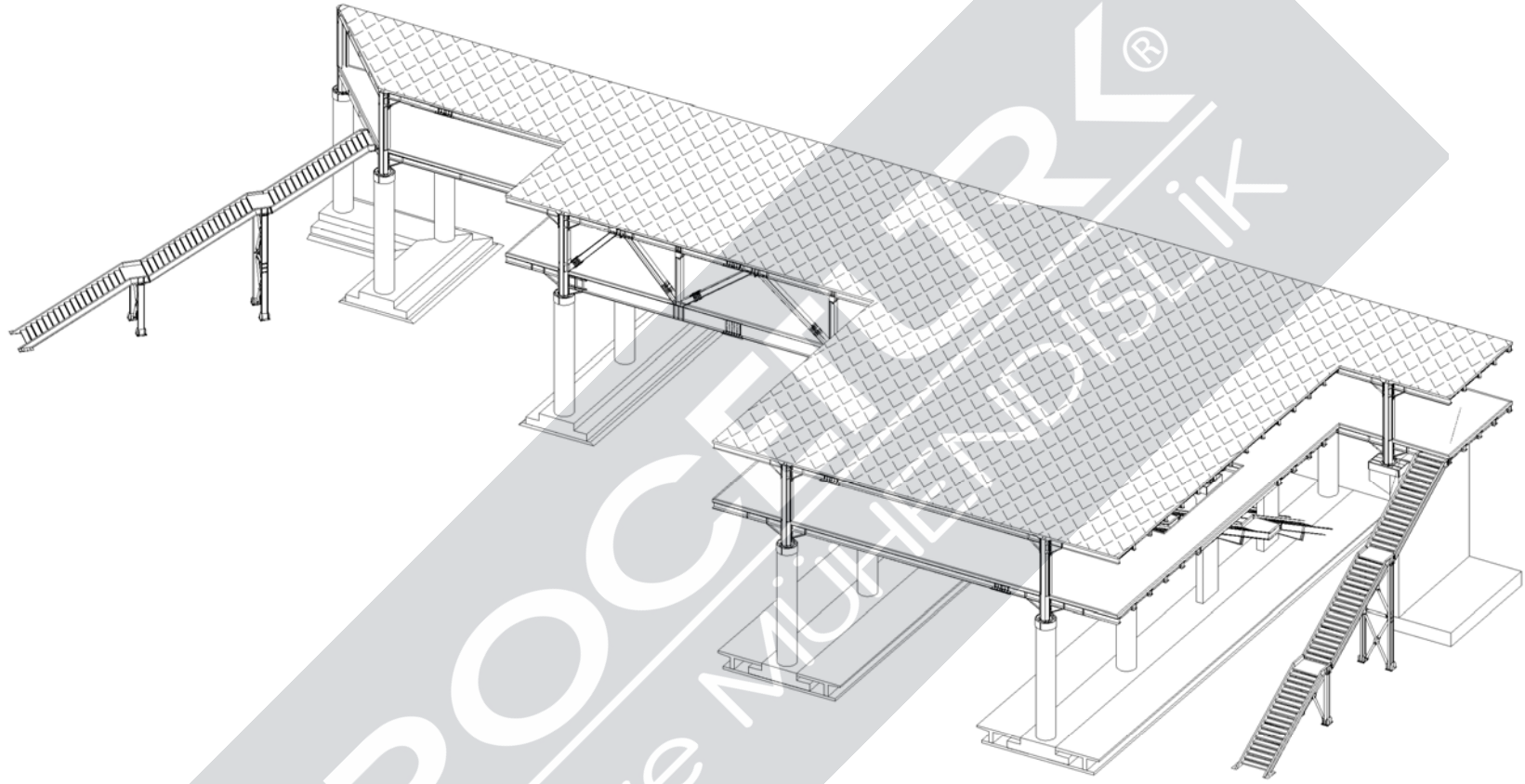

**Hasar Araştırma ve Güçlendirme**

**Damage Research and Reinforcement**



ÇELİK KONSTRÜKSİYON YAYA  
ÜST GEÇİT

İZOMETRİK GÖRÜNÜŞ-1A

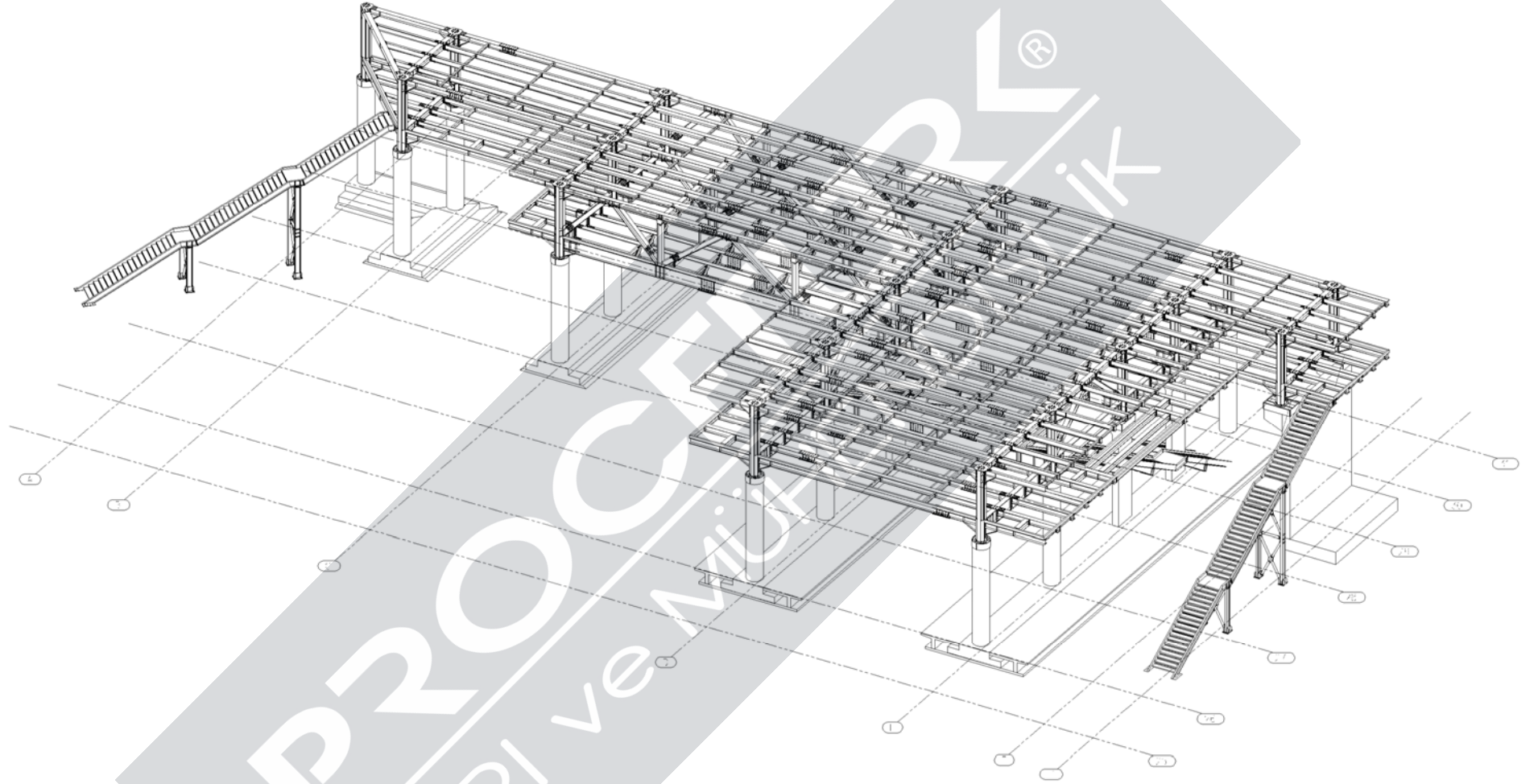

ÇELİK KONSTRÜKSİYON YAYA  
ÜST GEÇİT  
İZOMETRİK GÖRÜNÜŞ-1B

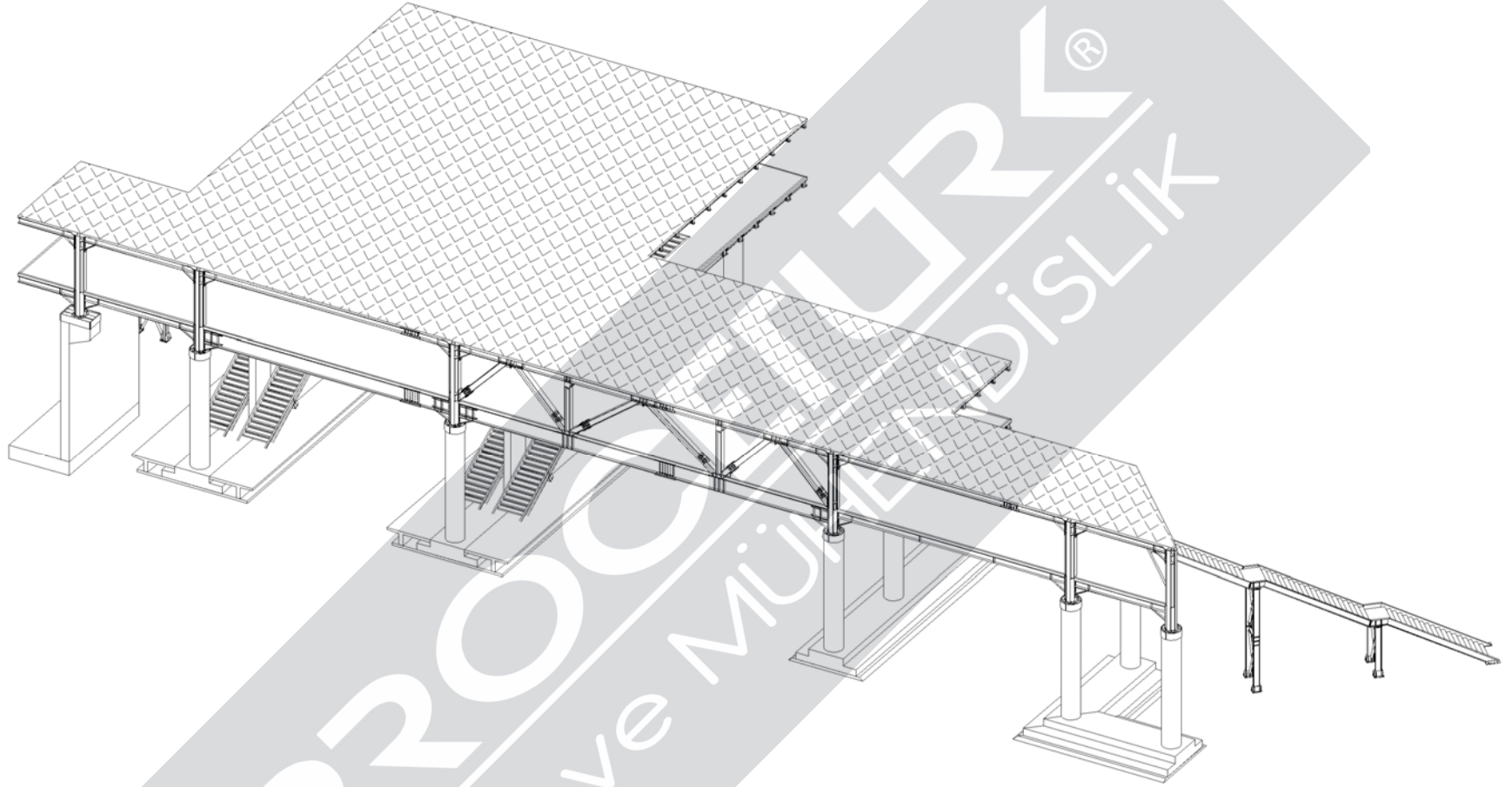

ÇELİK KONSTRÜKSİYON YAYA  
ÜST GEÇİT

İZOMETRİK GÖRÜNÜŞ-2A

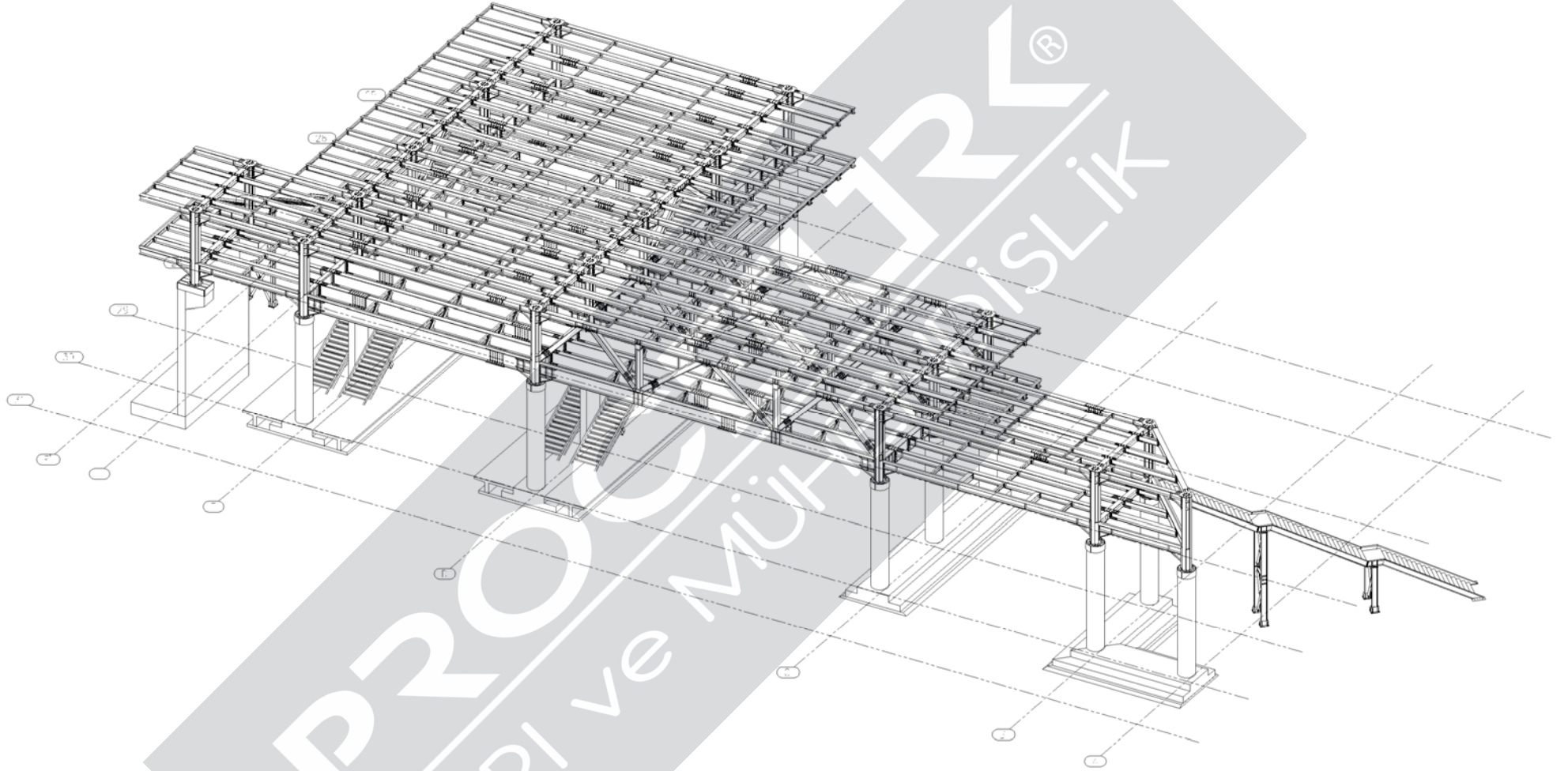

ÇELİK KONSTRÜKSİYON YAYA  
ÜST GEÇİT  
İZOMETRİK GÖRÜNÜŞ-2B

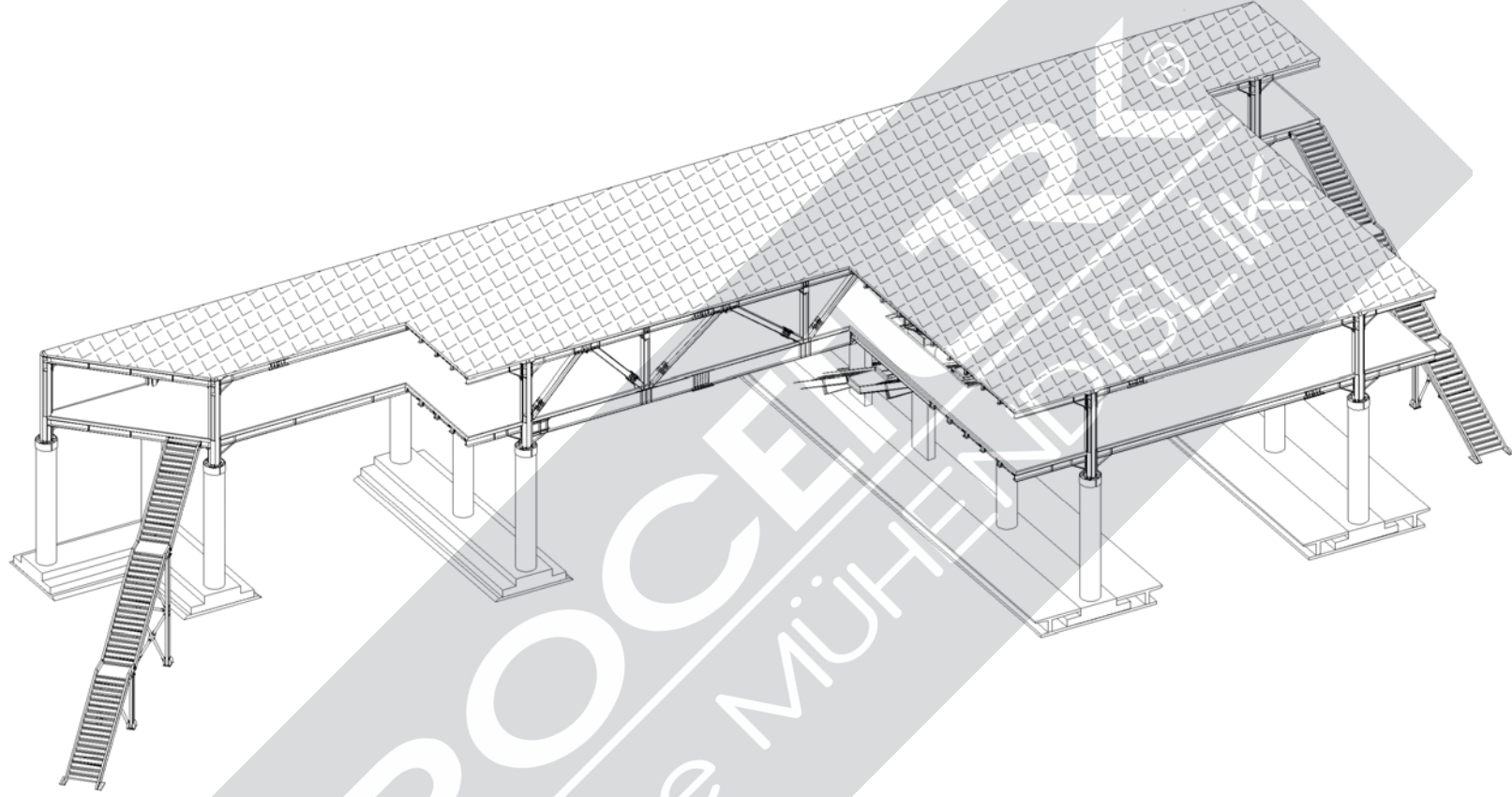

ÇELİK KONSTRÜKSİYON YAYA  
ÜST GEÇİT

İZOMETRİK GÖRÜNÜŞ-3A

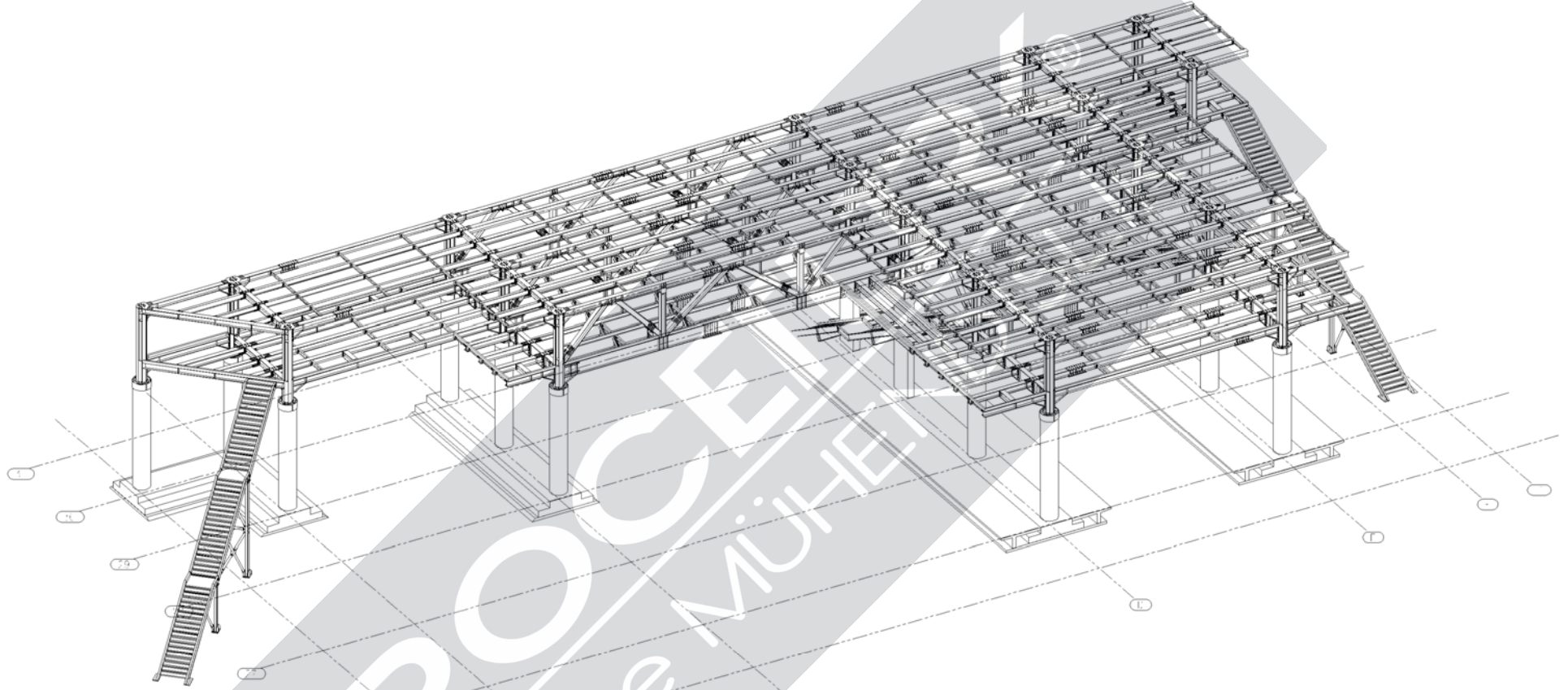

ÇELİK KONSTRÜKSİYON YAYA  
ÜST GEÇİT

İZOMETRİK GÖRÜNÜŞ-3B

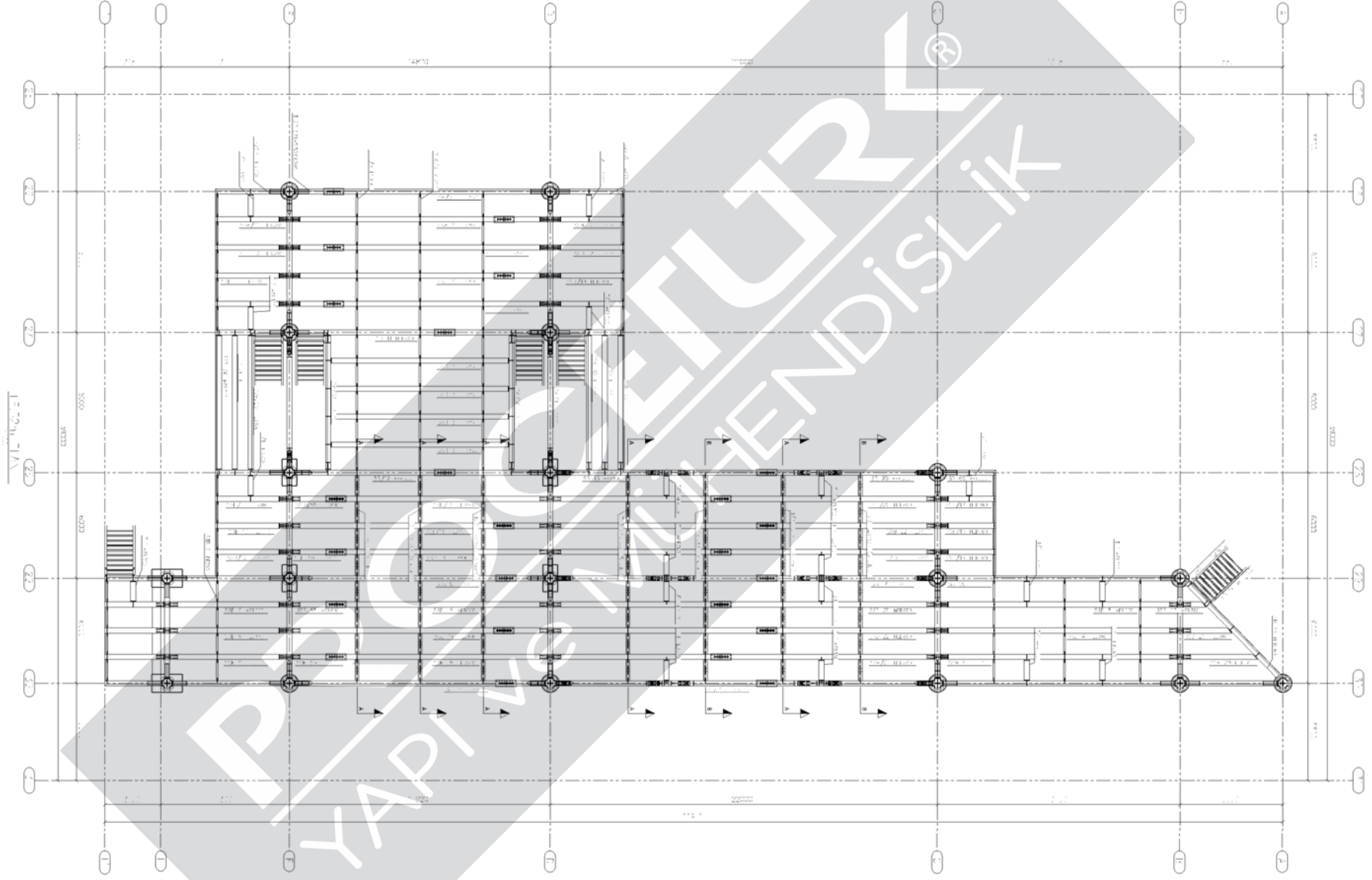



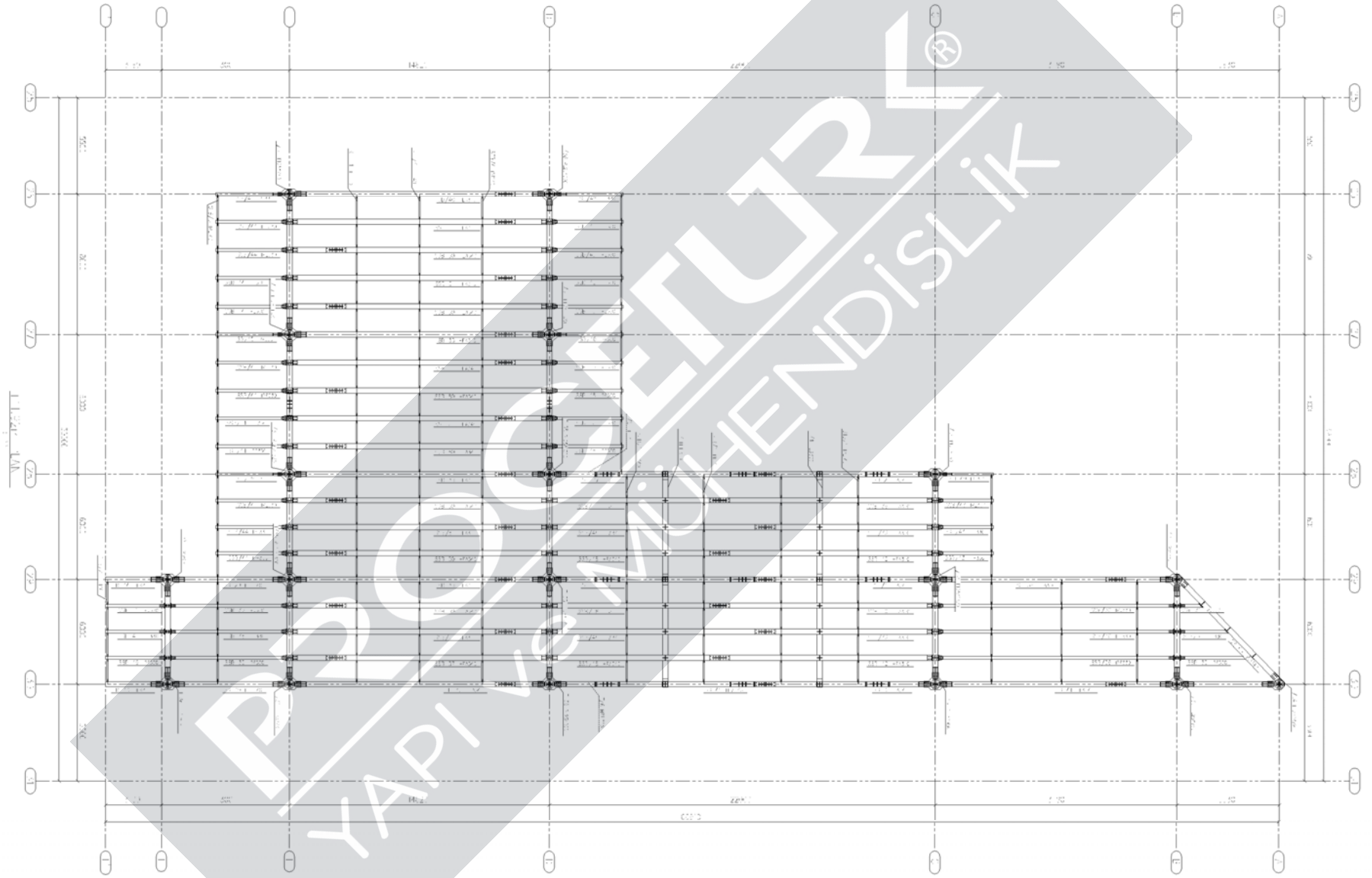

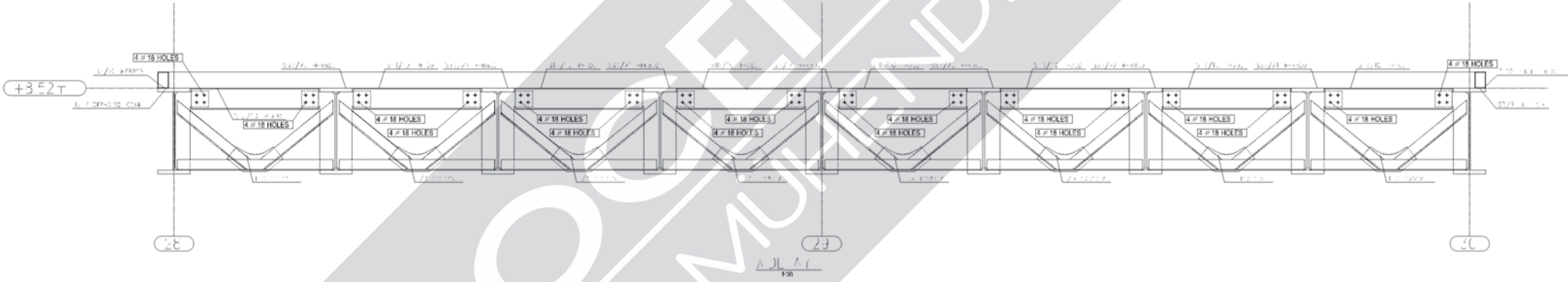

**PRO FUR**<sup>®</sup>  
 YAPI VE MÜHÜR MÜHÜR  
 MÜHÜR MÜHÜR MÜHÜR

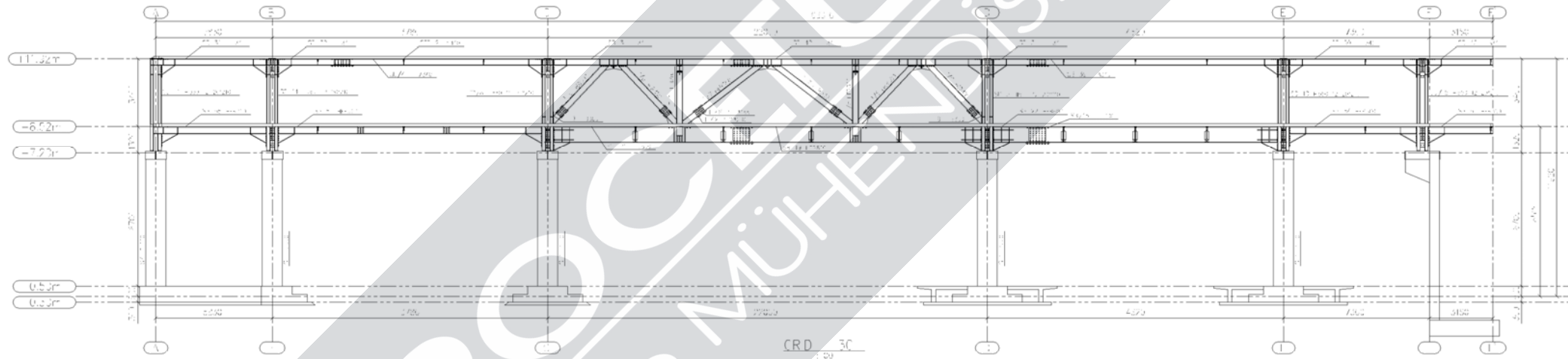

PROCCENLUR<sup>®</sup>  
YAPI VE MÜHÜR MÜHÜR MÜHÜR

CRD 30  
1/50

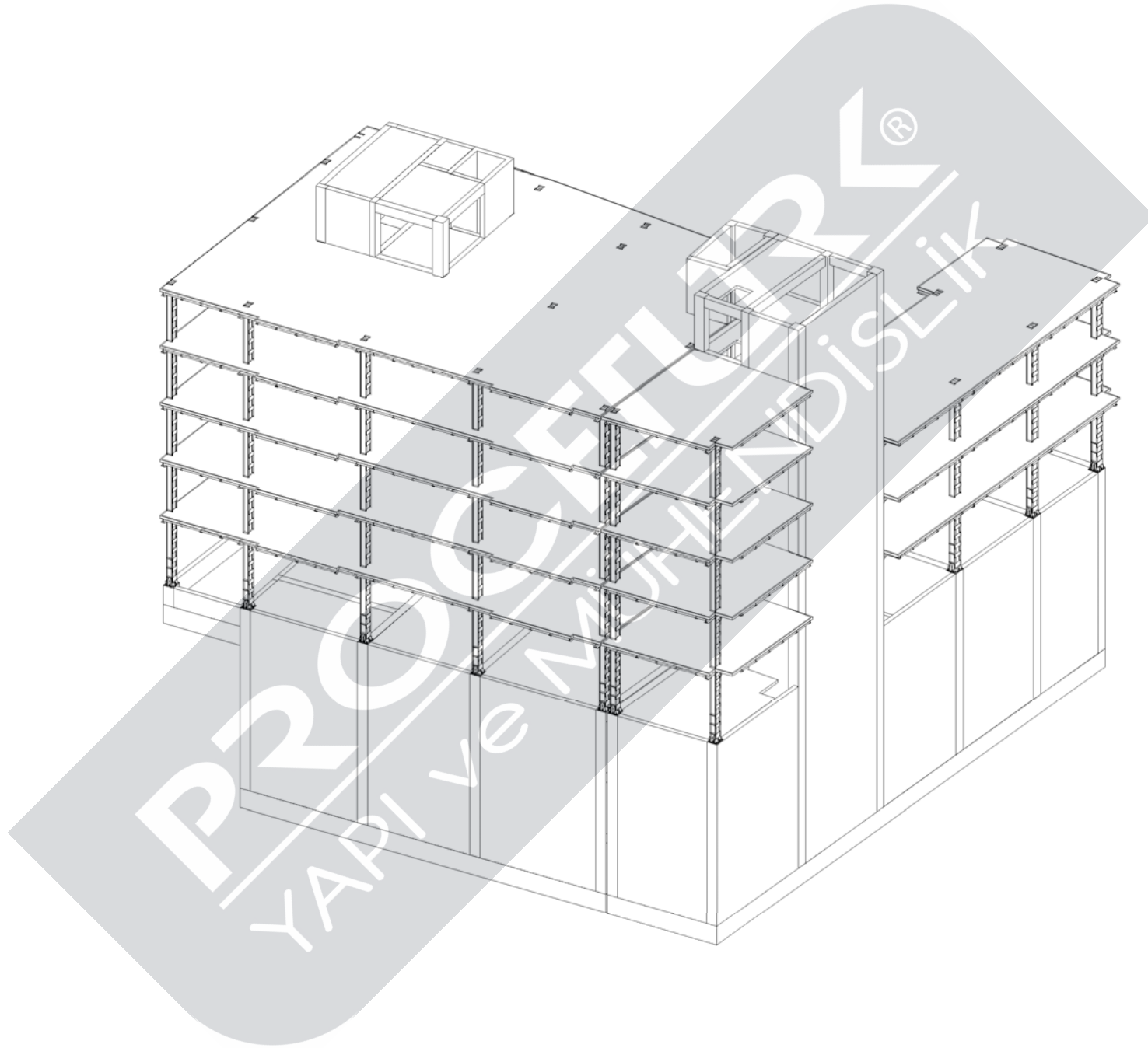

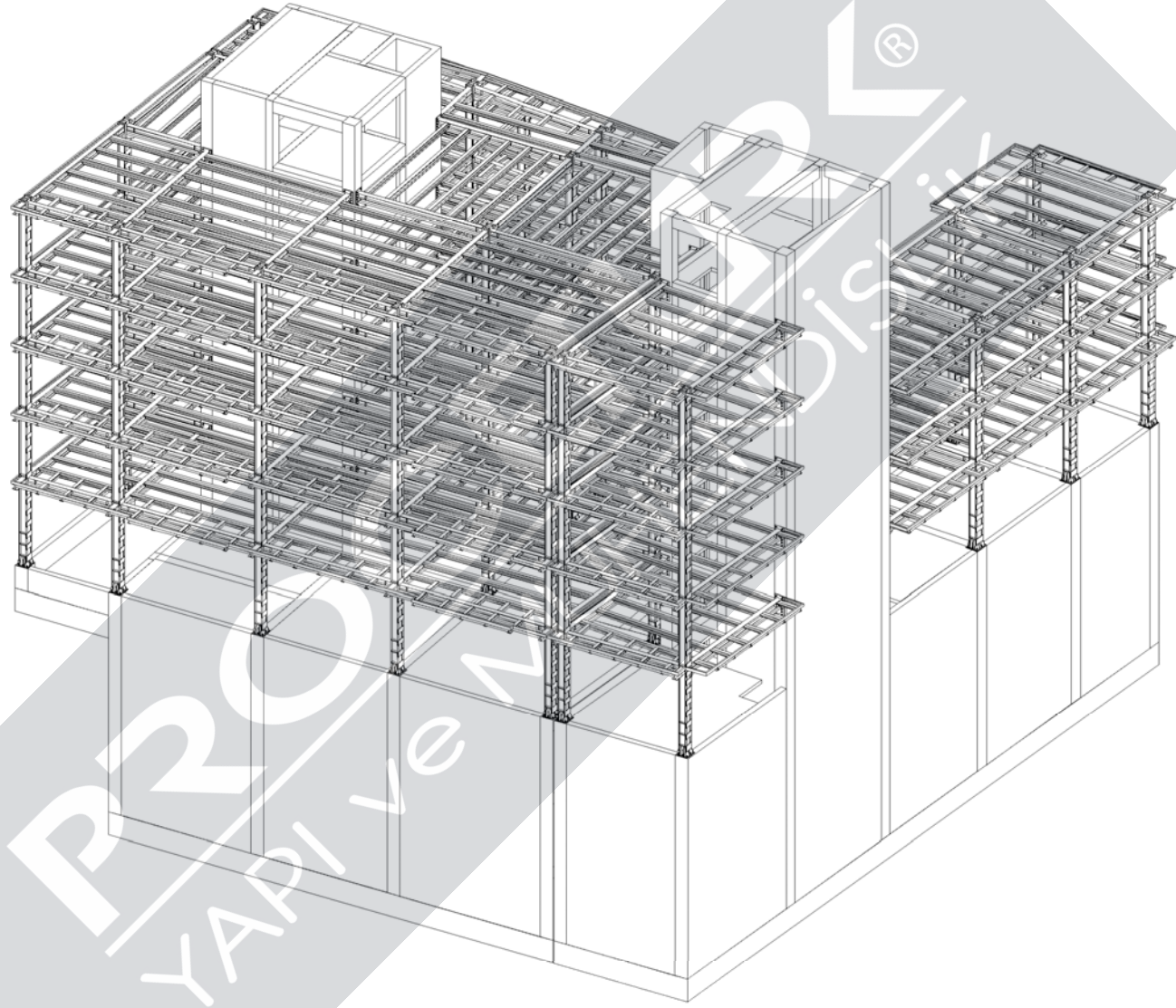

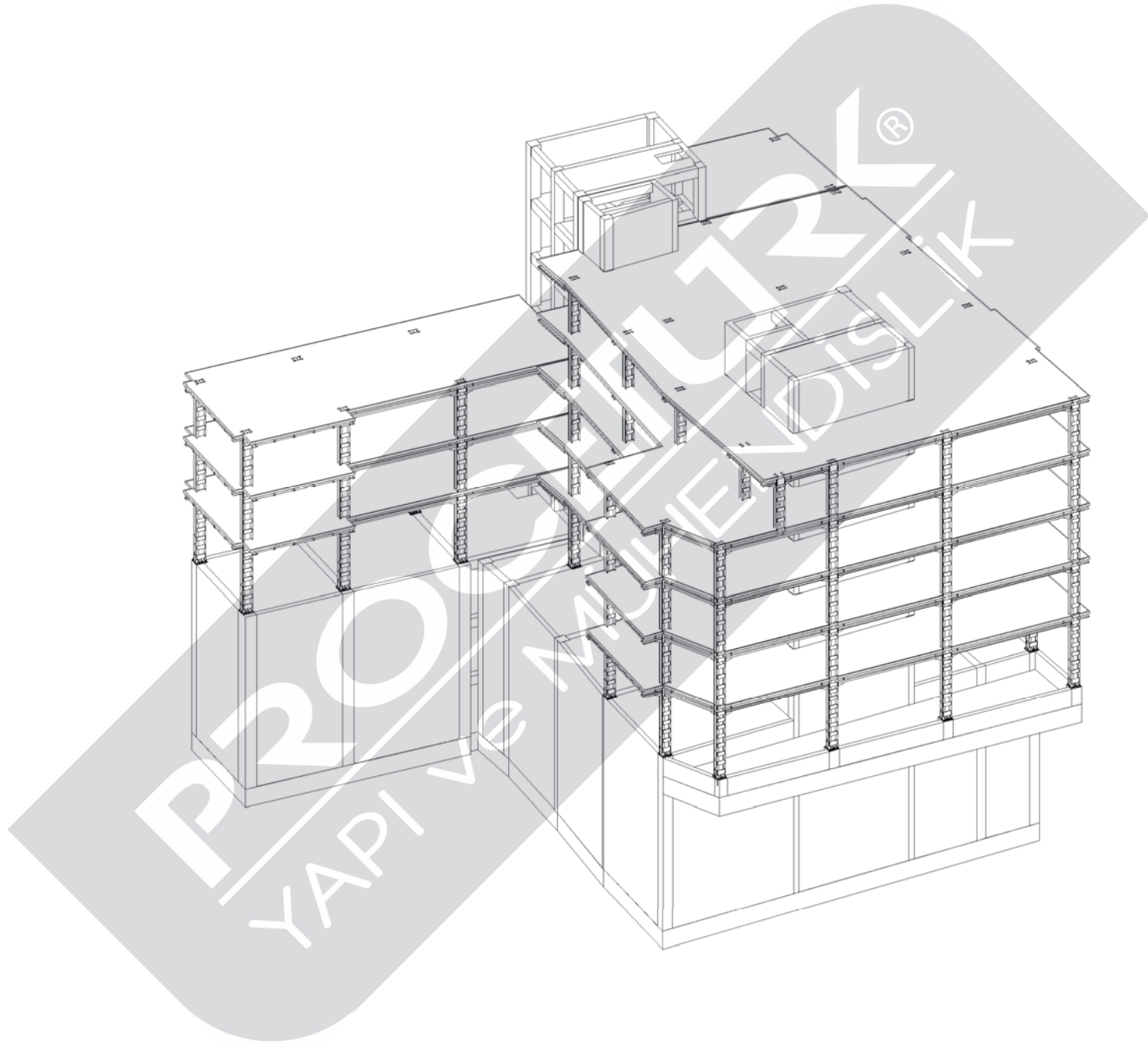

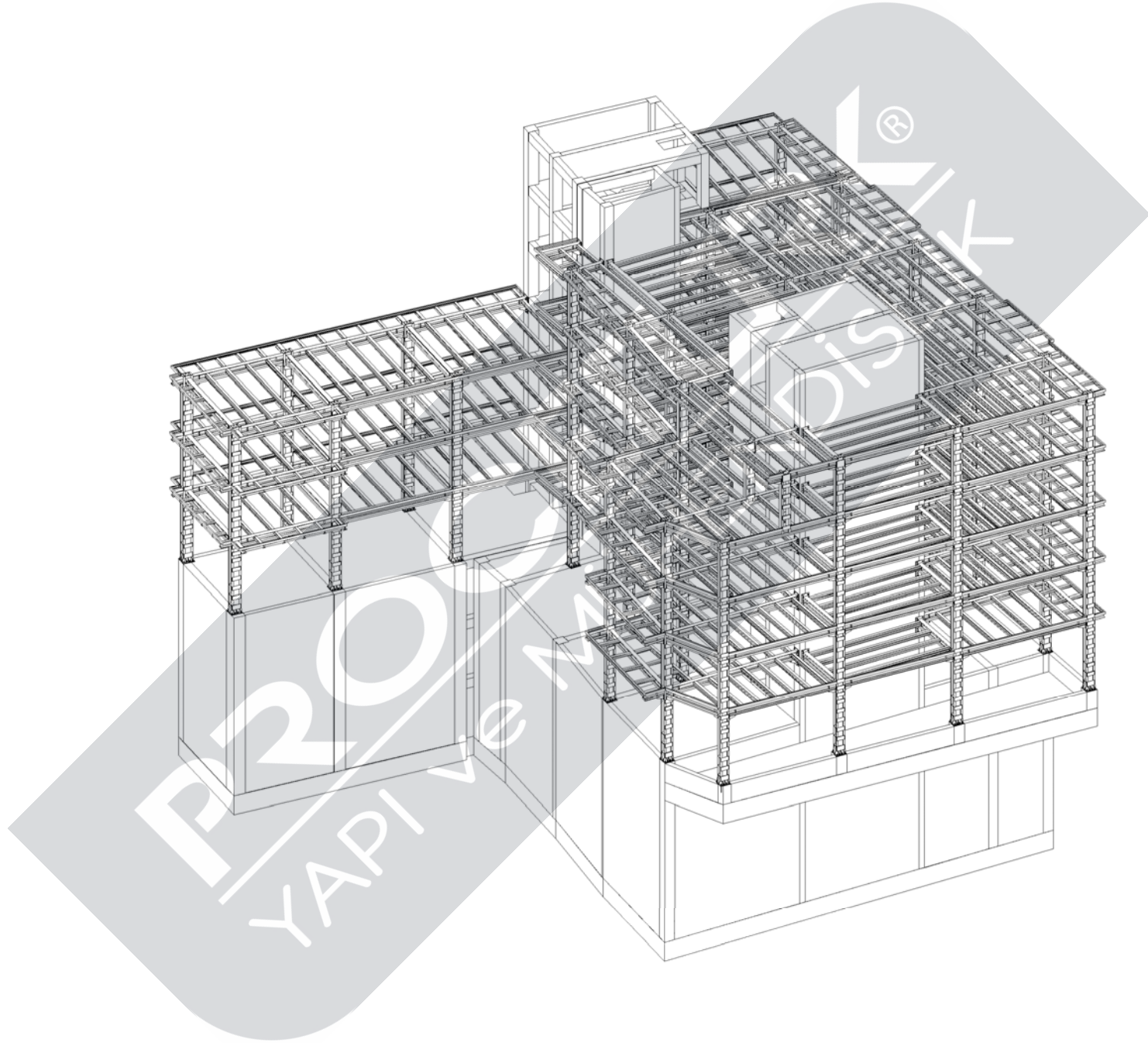

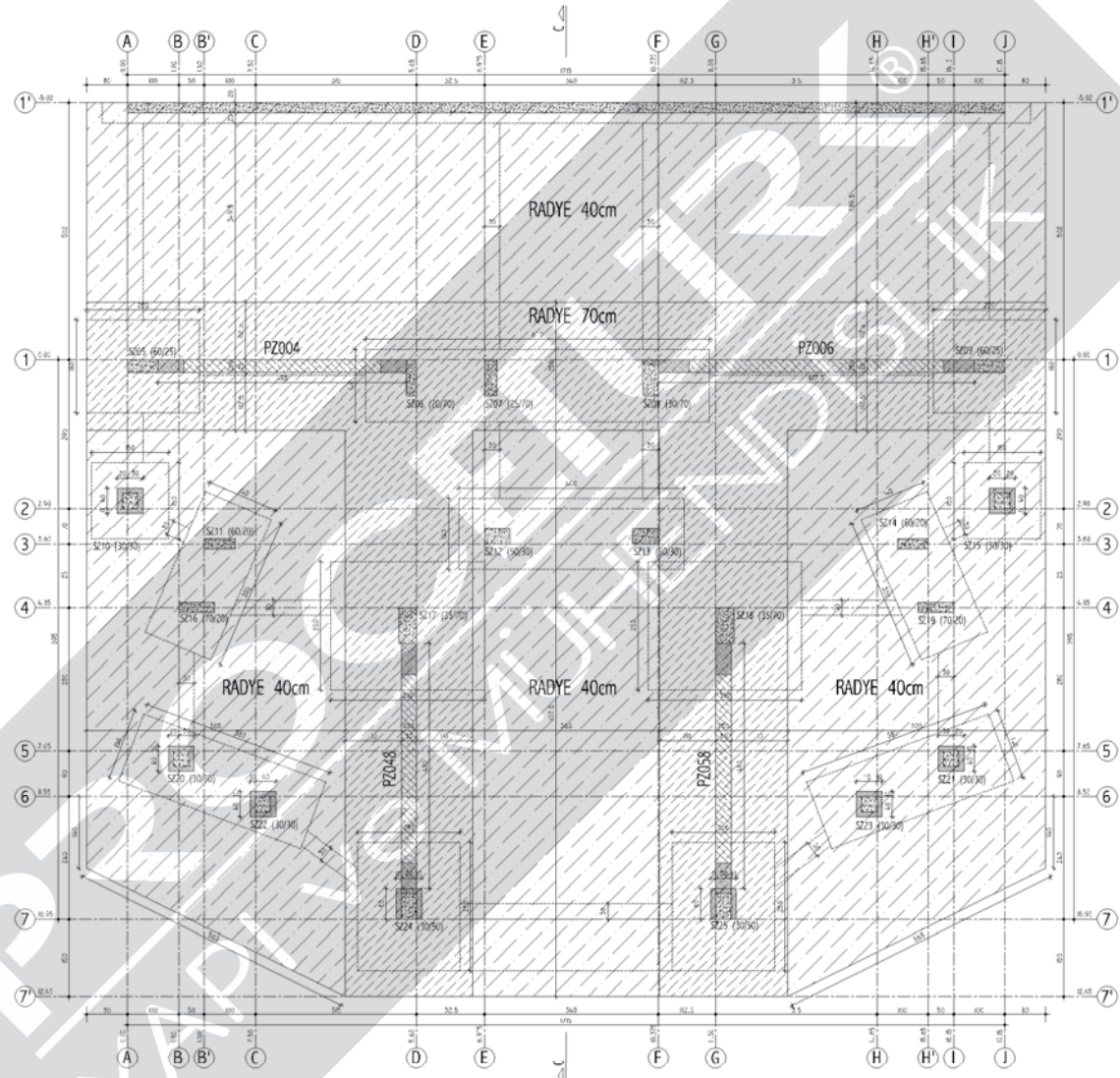

TEMEL APLİKASYON PLANI (1/50)

±0.70



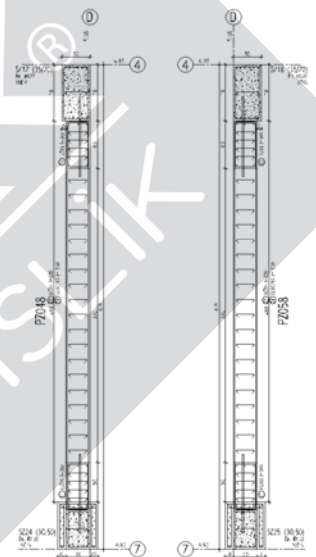
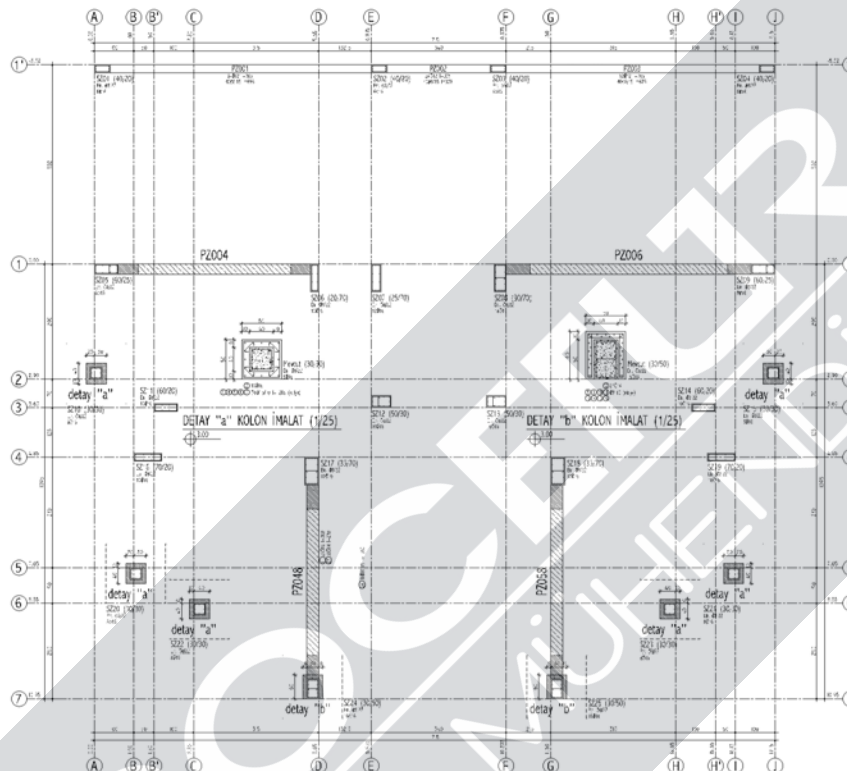

METRAL

KALUP (m<sup>2</sup>) : 188.59

BETON (m<sup>3</sup>) : 20.57

Ø 6-12 (kg) : 1174.89

Ø 14-50 (kg) : 1851.2



Çizim Ölçüsü Tablosu

Çizim Ölçüsü	Çizim Ölçüsü	Çizim Ölçüsü	Çizim Ölçüsü
1/50	1/50	1/50	1/50
1/25	1/25	1/25	1/25
1/10	1/10	1/10	1/10
1/5	1/5	1/5	1/5
1/2	1/2	1/2	1/2
1/1	1/1	1/1	1/1
1/0.5	1/0.5	1/0.5	1/0.5
1/0.2	1/0.2	1/0.2	1/0.2
1/0.1	1/0.1	1/0.1	1/0.1
1/0.05	1/0.05	1/0.05	1/0.05
1/0.02	1/0.02	1/0.02	1/0.02
1/0.01	1/0.01	1/0.01	1/0.01

Çizim Ölçüsü	Çizim Ölçüsü	Çizim Ölçüsü	Çizim Ölçüsü
1/50	1/50	1/50	1/50
1/25	1/25	1/25	1/25
1/10	1/10	1/10	1/10
1/5	1/5	1/5	1/5
1/2	1/2	1/2	1/2
1/1	1/1	1/1	1/1
1/0.5	1/0.5	1/0.5	1/0.5
1/0.2	1/0.2	1/0.2	1/0.2
1/0.1	1/0.1	1/0.1	1/0.1
1/0.05	1/0.05	1/0.05	1/0.05
1/0.02	1/0.02	1/0.02	1/0.02
1/0.01	1/0.01	1/0.01	1/0.01

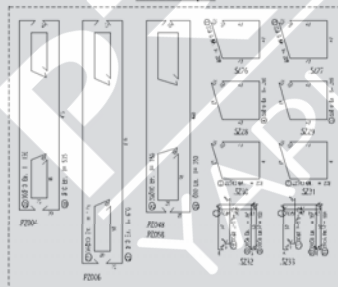

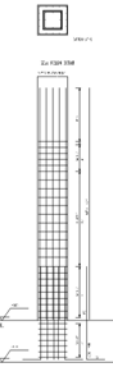
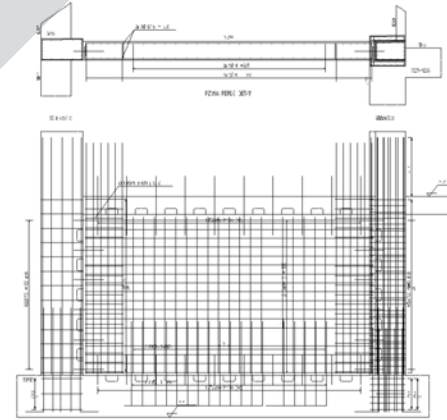
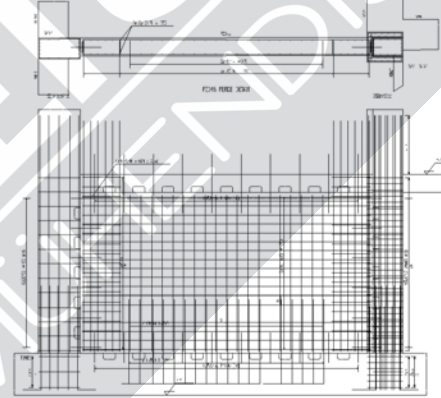
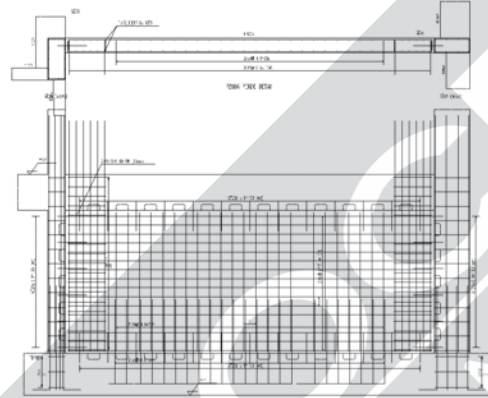
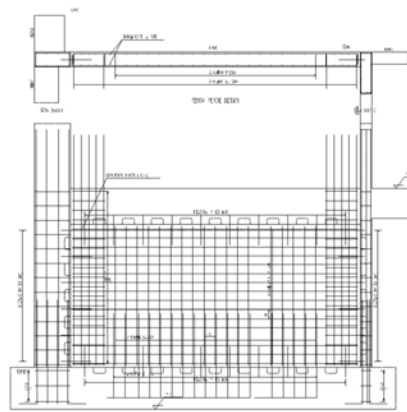

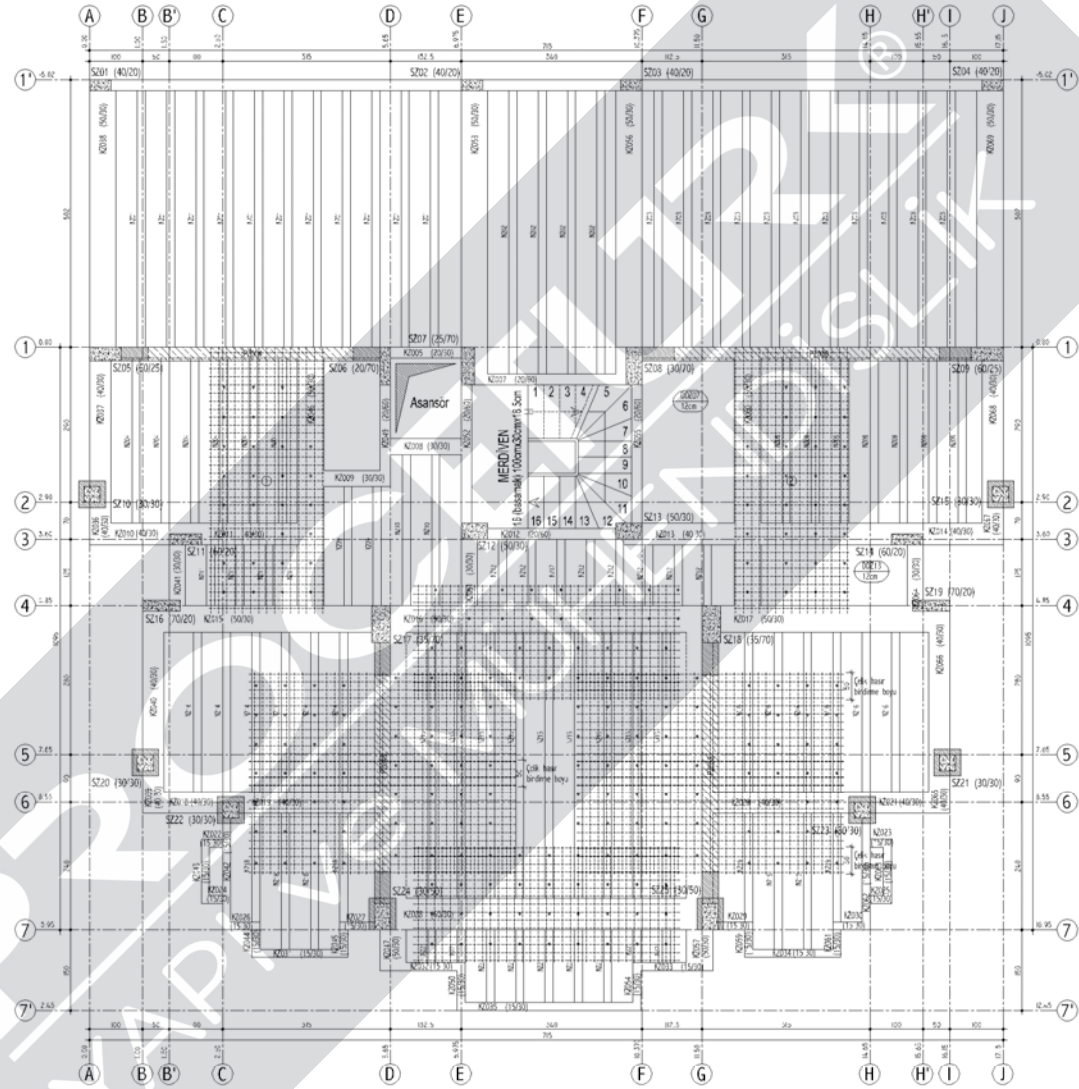

ZEMİN KAT KALIP PLANI (1/50)  
 ±3.00

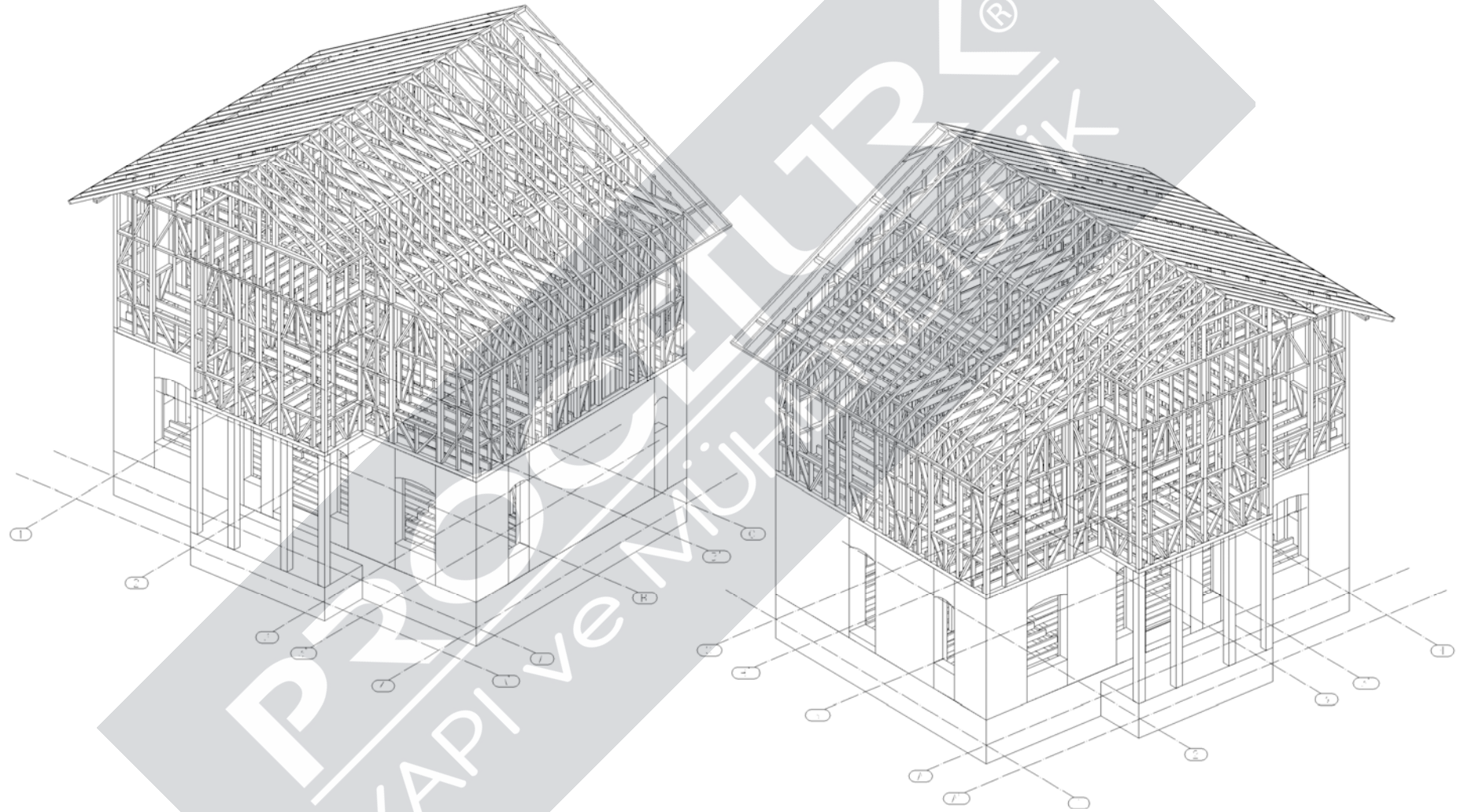

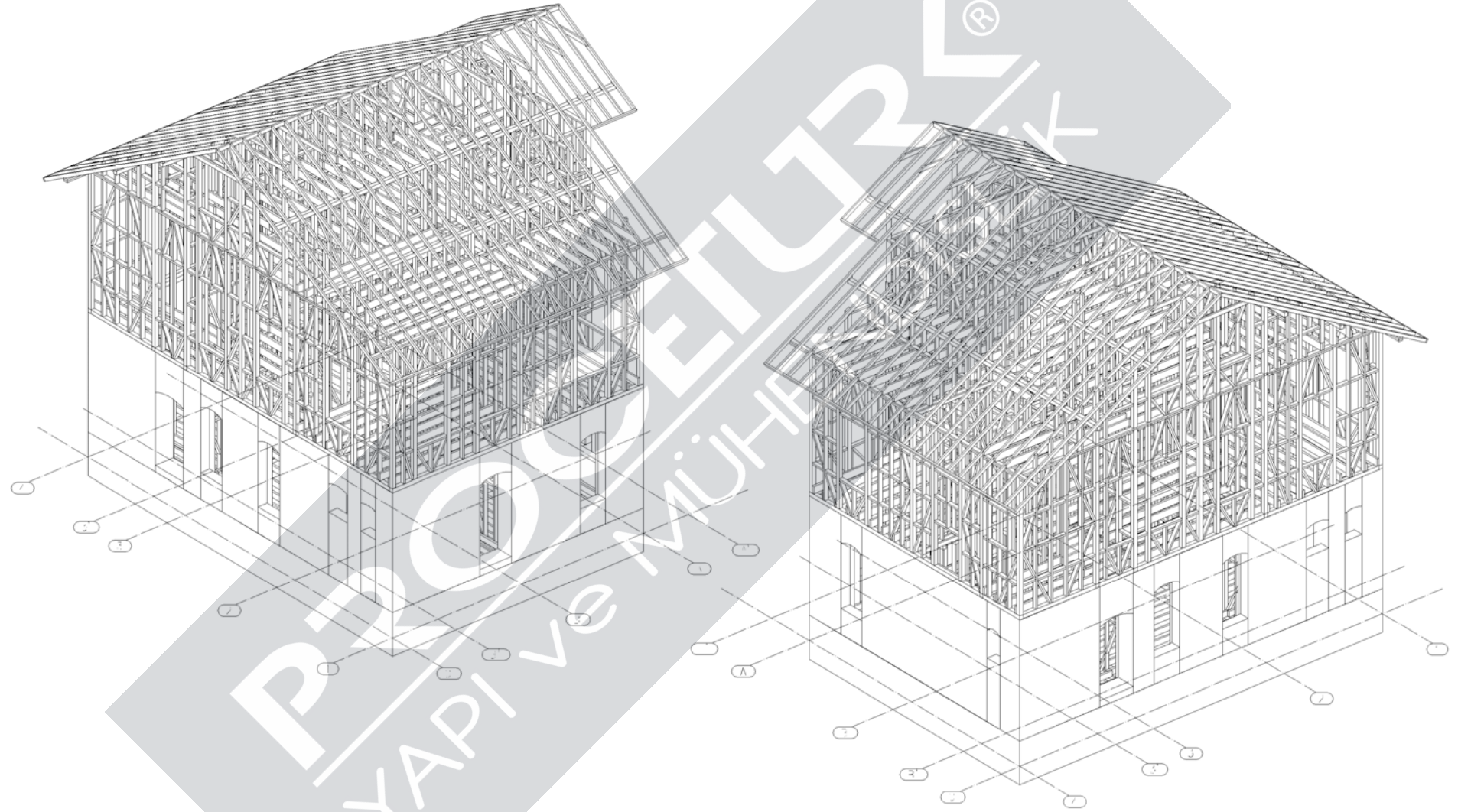

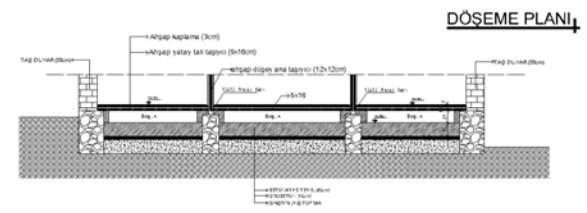
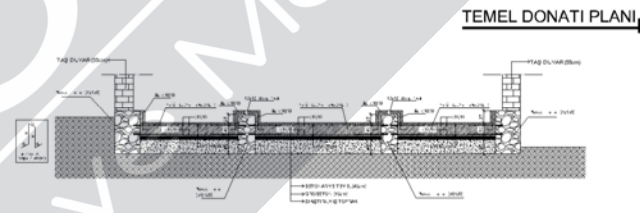
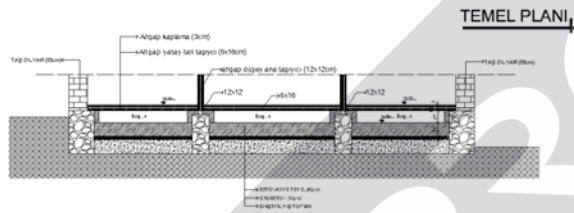
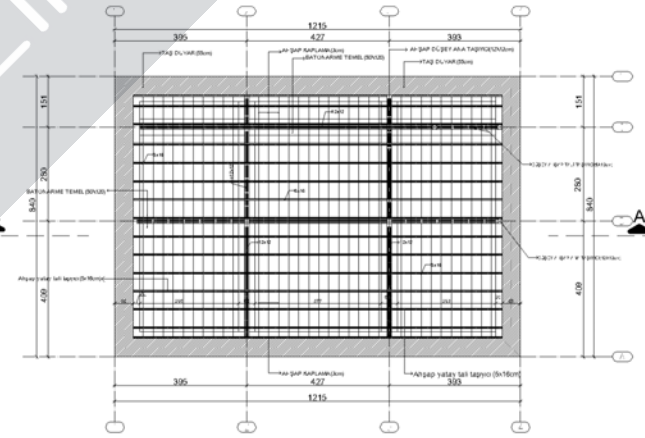
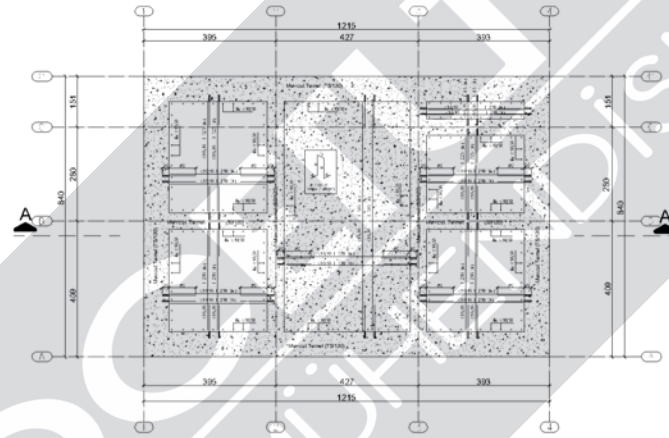
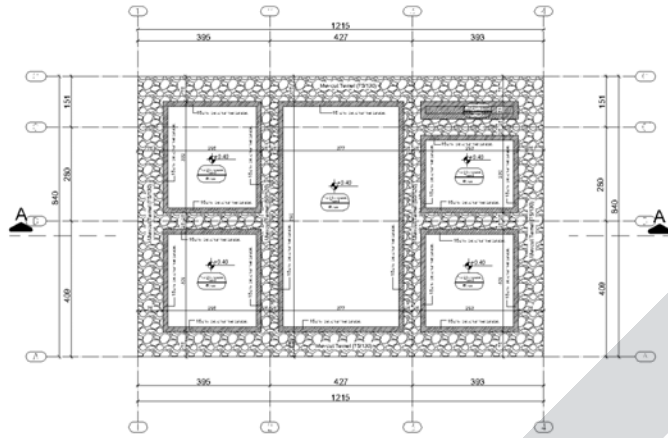

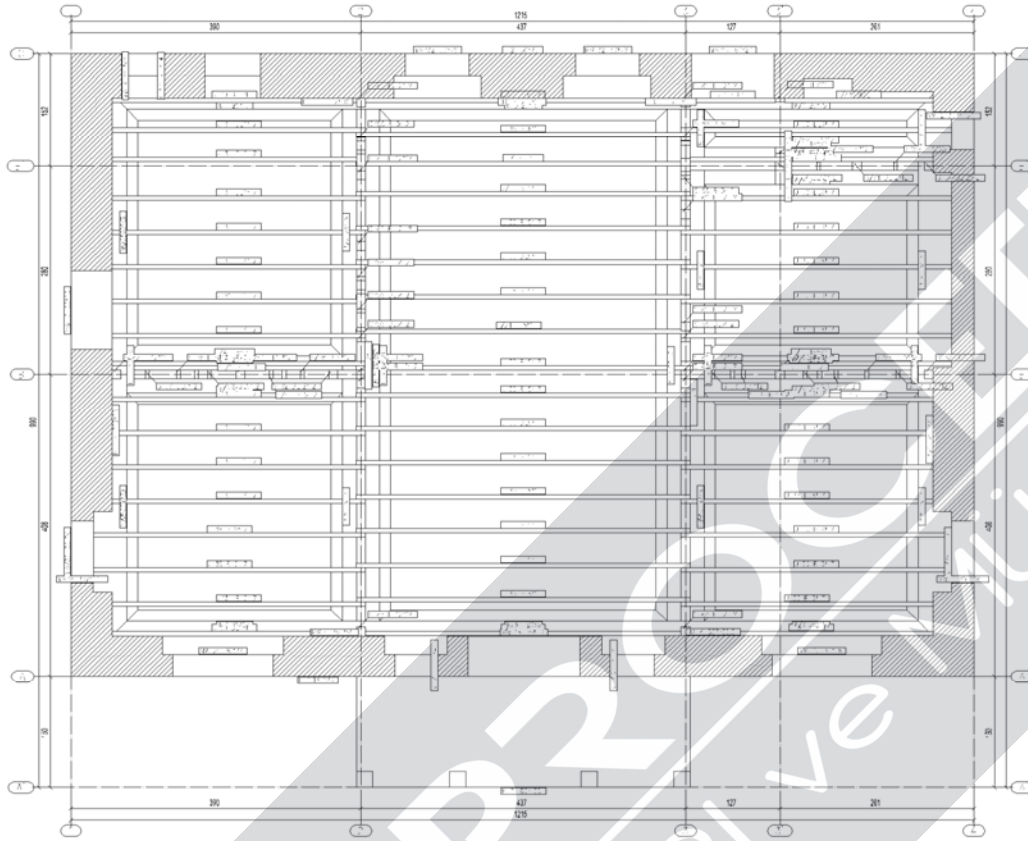

**+0.75m KOTU PLANI**  
ÖLÇEK: 1/20

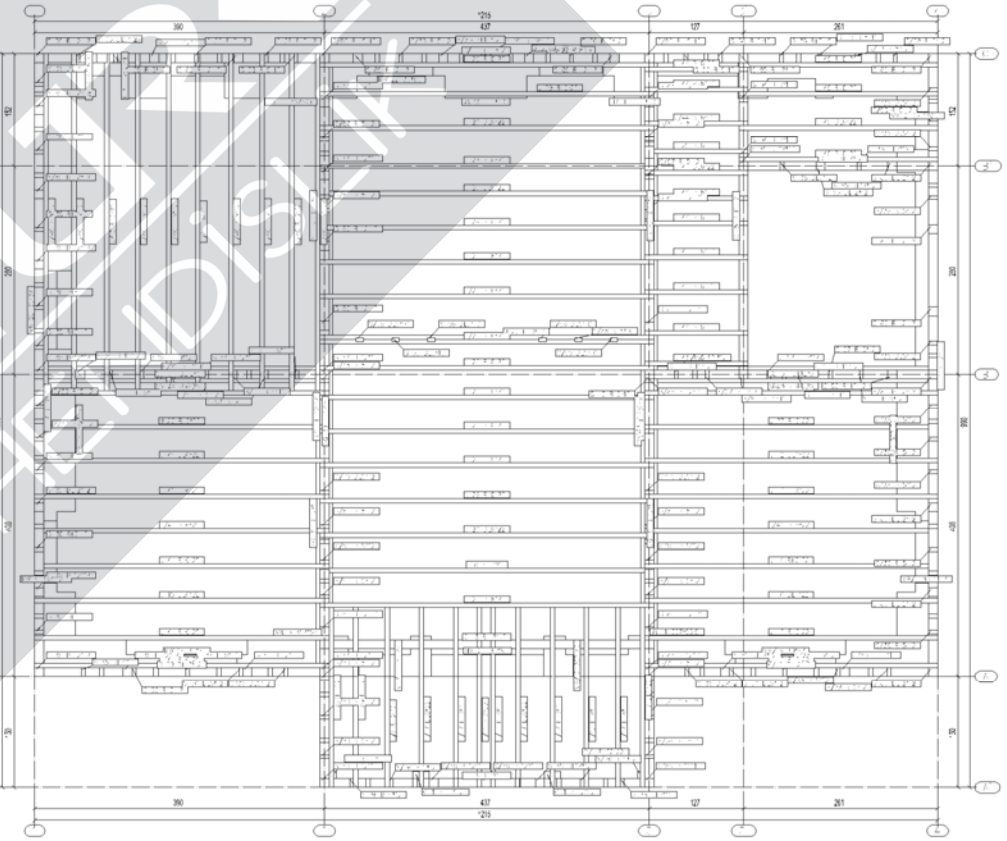

**+4.69m KOTU PLANI**  
ÖLÇEK: 1/20

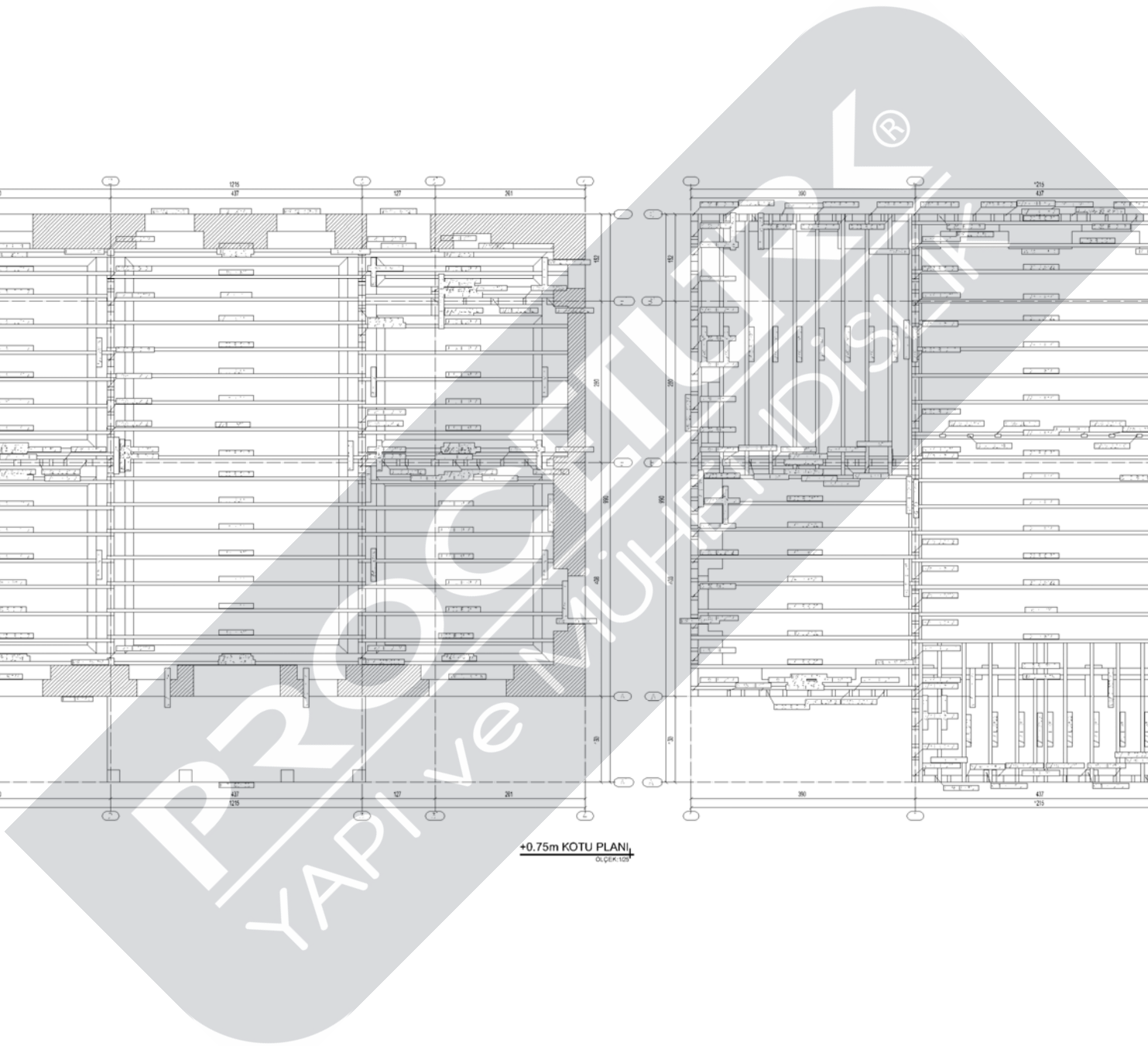

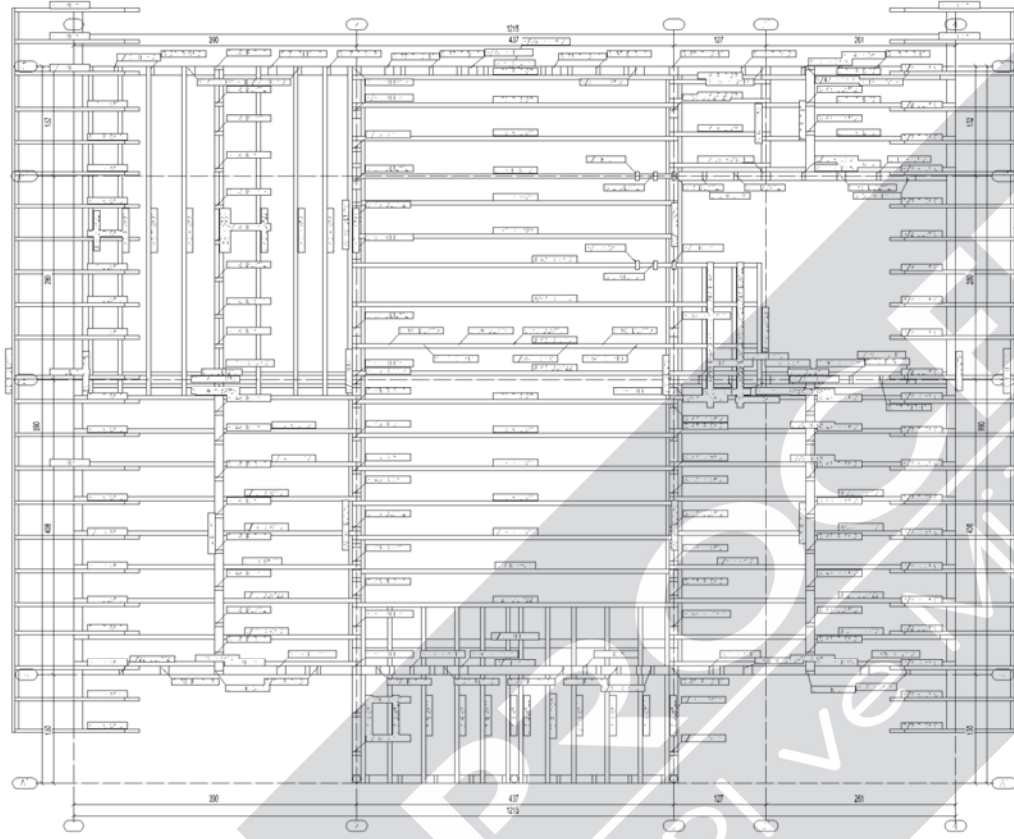

**+8.84m KOTU PLANI**  
ölçek:1/20



**ÇATI ÜSTEN GÖRÜNÜŞÜ**  
ölçek:1/20



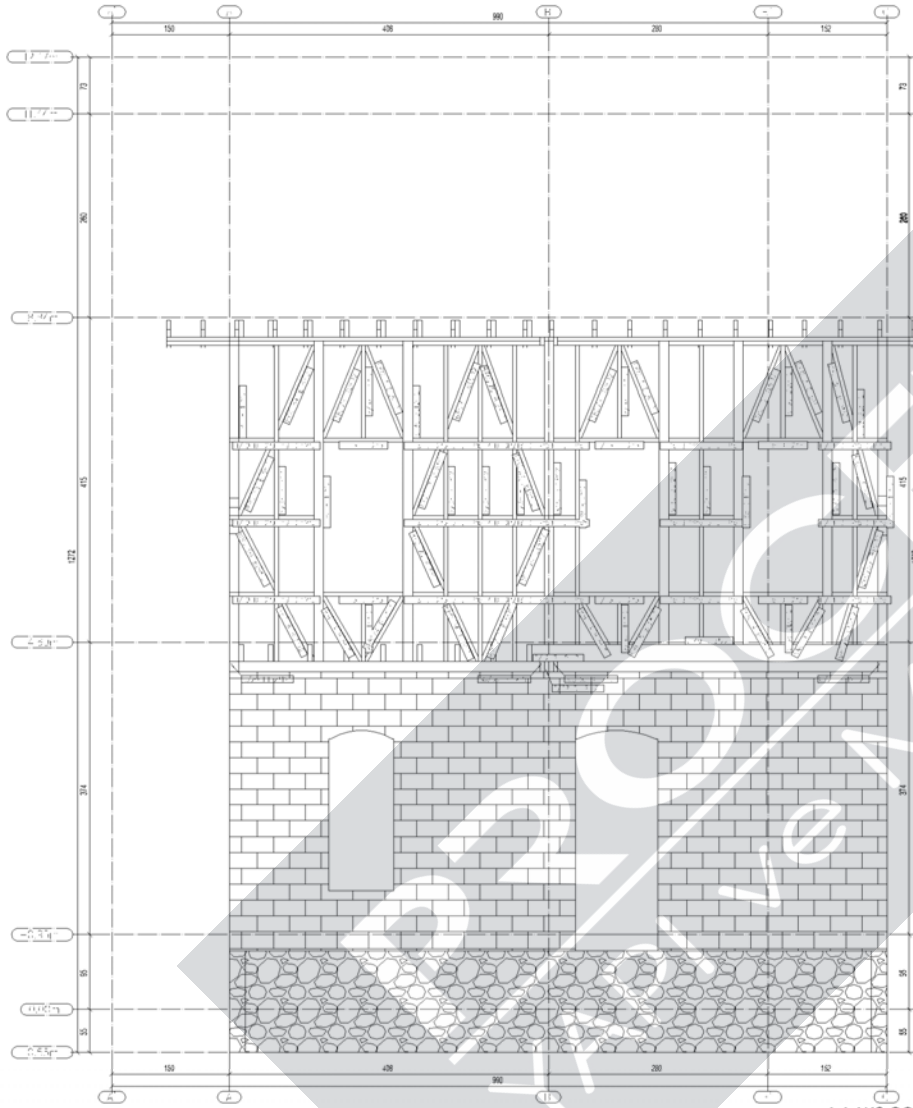

**1-1 AKS GORUNUSU**  
ÖLÇEK:1/25

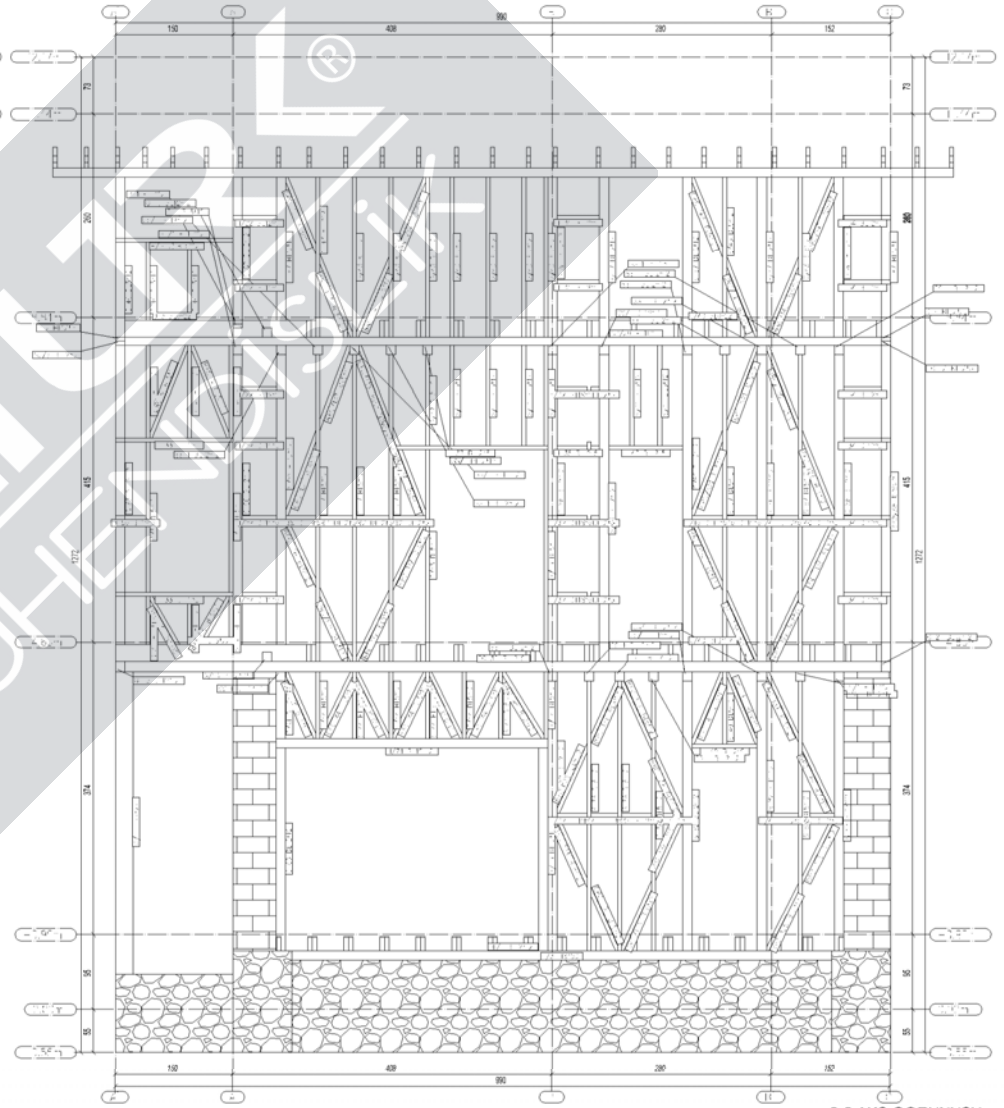

**2-2 AKS GORUNUSU**  
ÖLÇEK:1/25

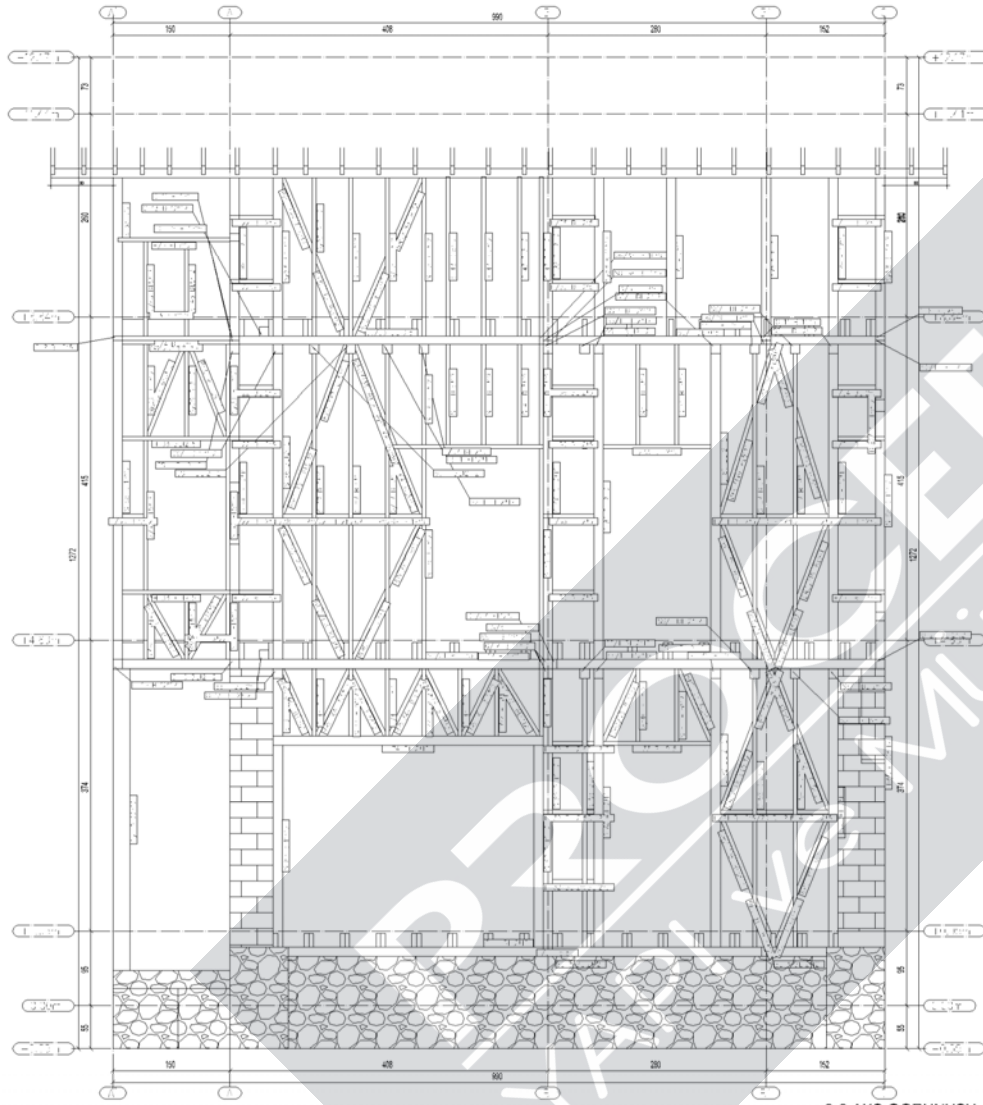

**3-3 AKS GORUNUSU,**  
0.ÇER.1/25

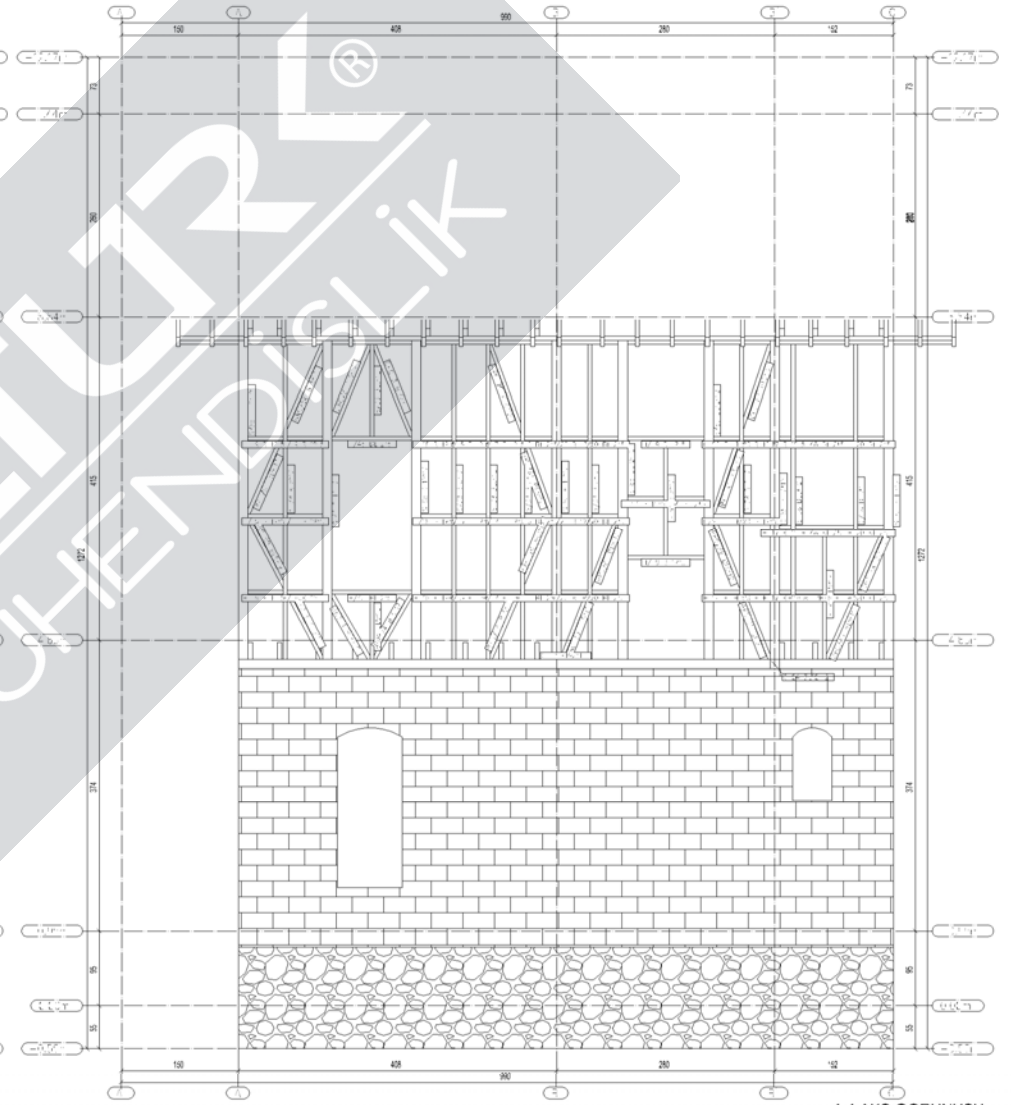

**4-4 AKS GORUNUSU,**  
0.ÇER.1/25

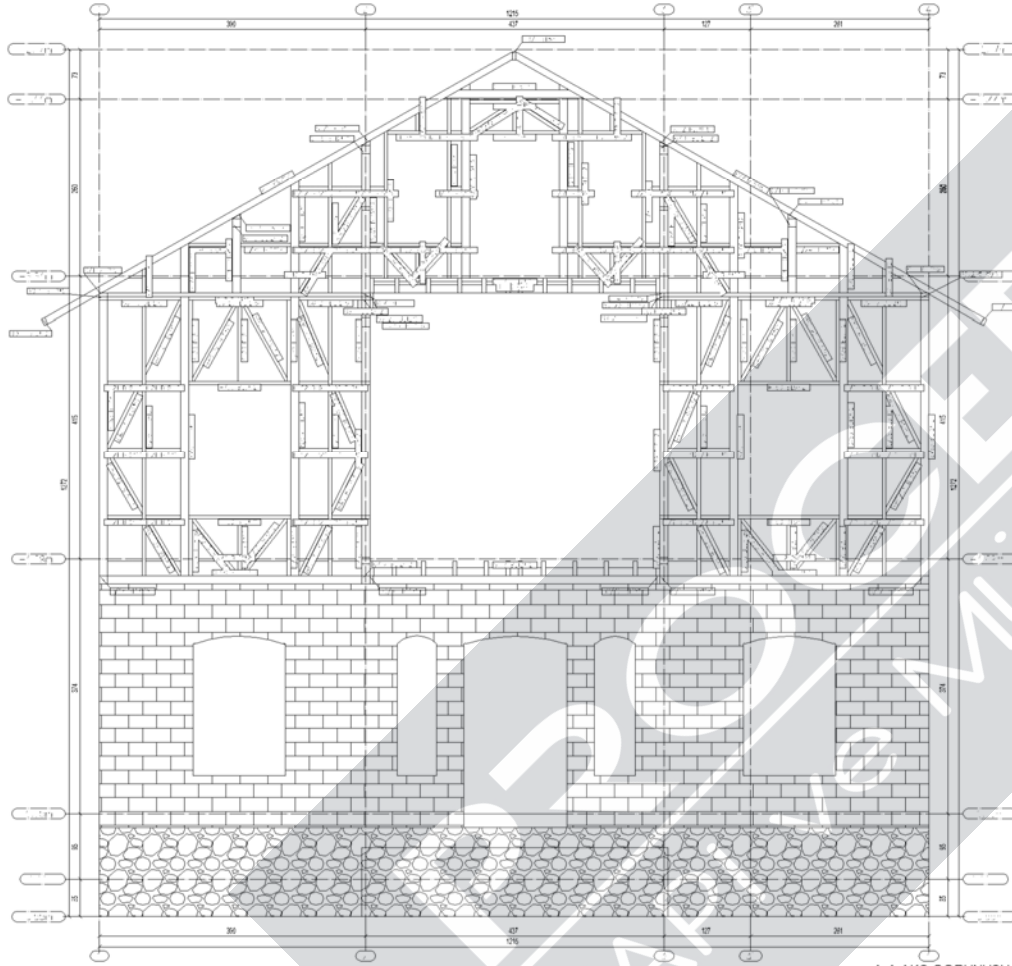

A-A AKS GORUNUSU  
0,5çx1,0ç

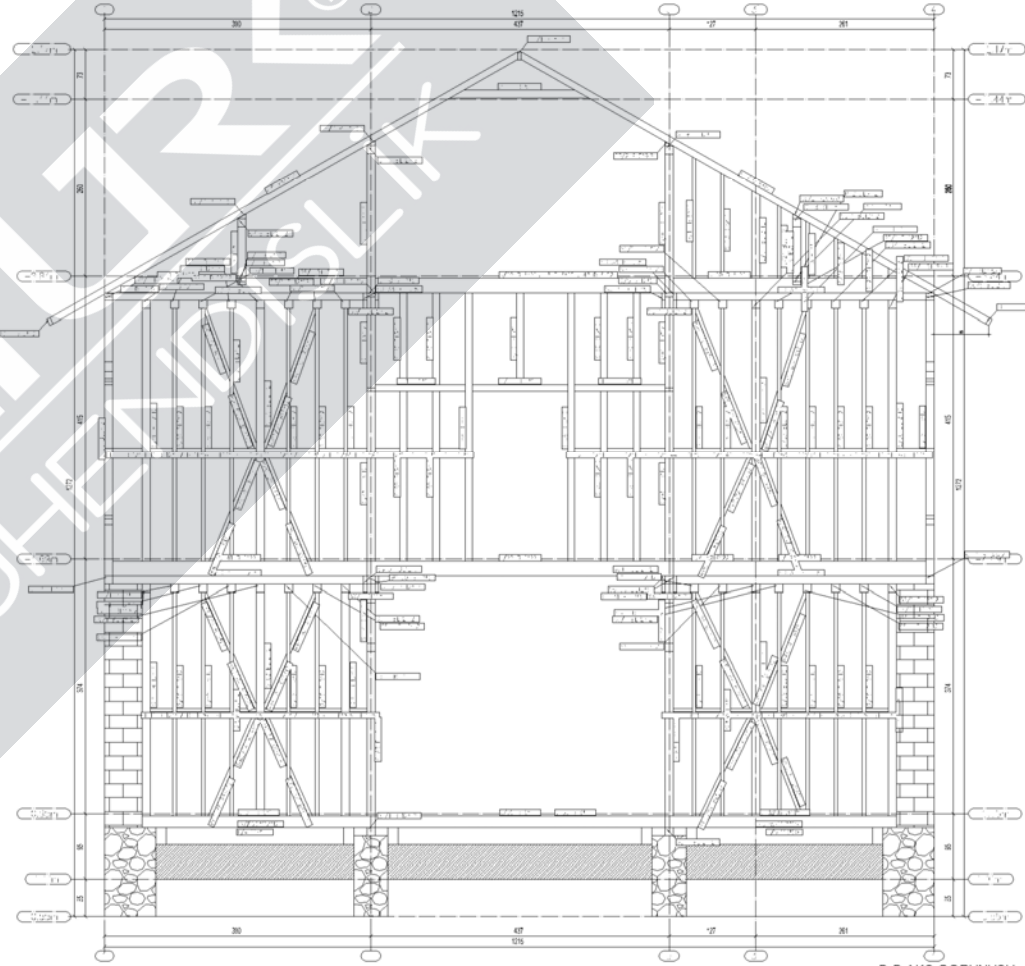

B-B AKS GORUNUSU  
0,5çx1,0ç

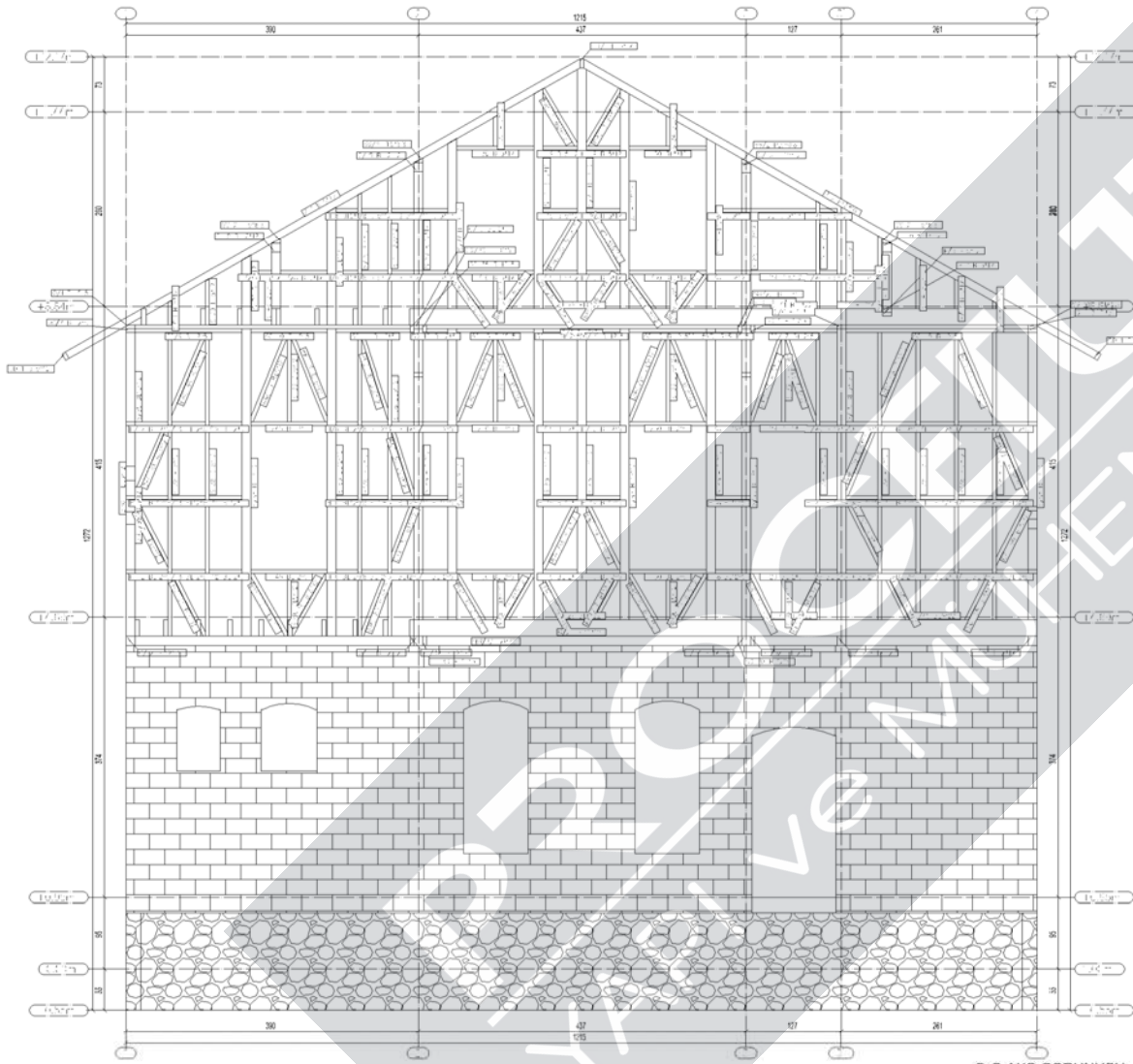

**C-C AKS GORUNUSU**  
06.06x1125

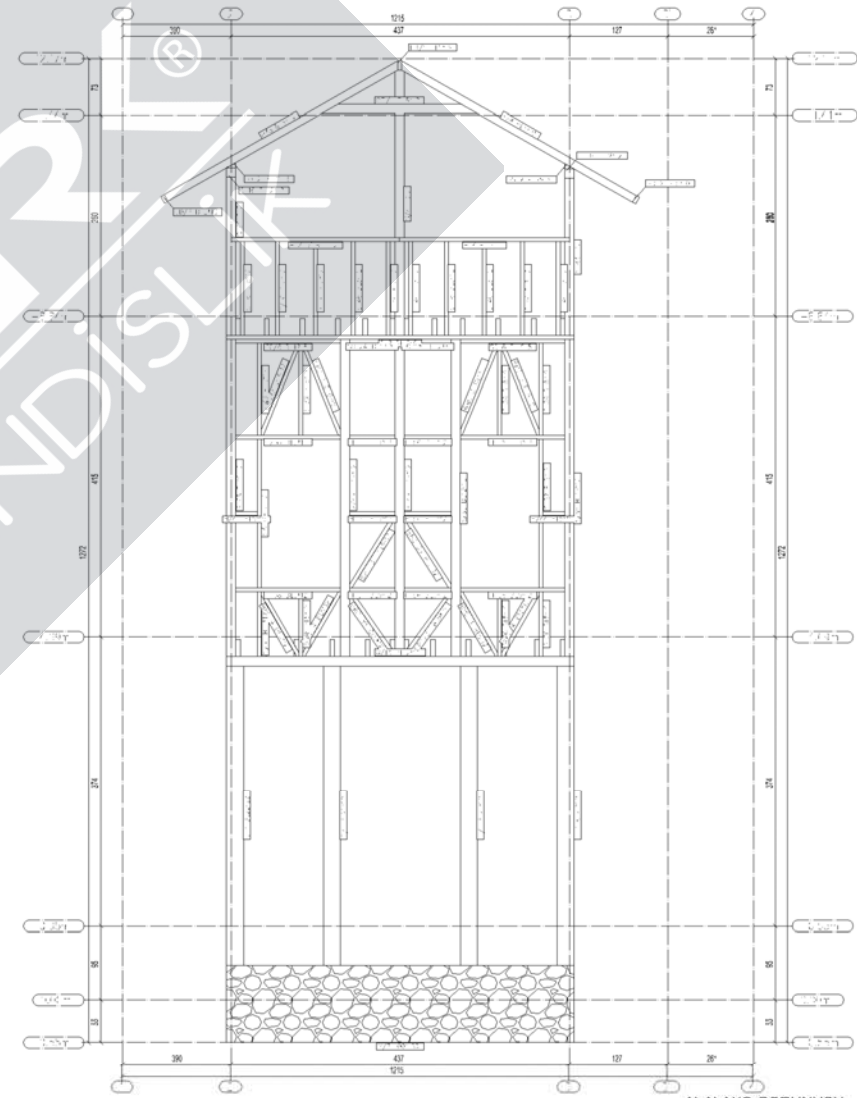

**A-A' AKS GORUNUSU**  
06.06x1125

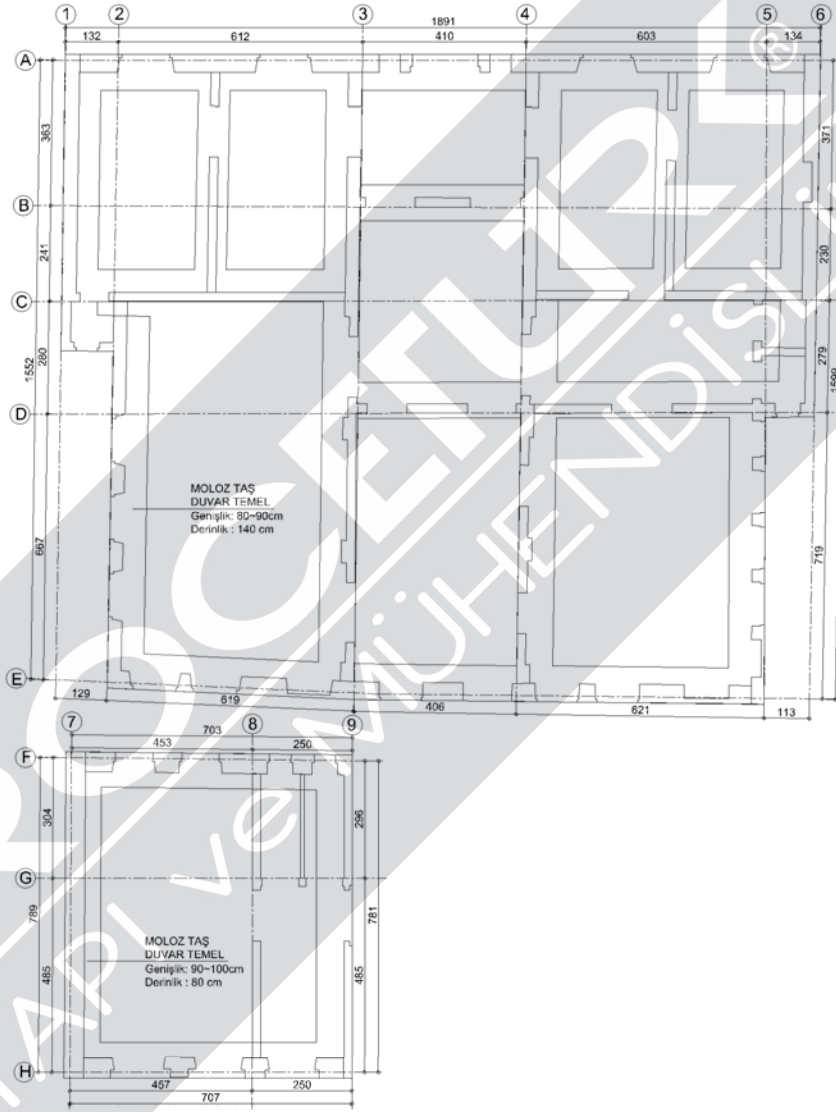

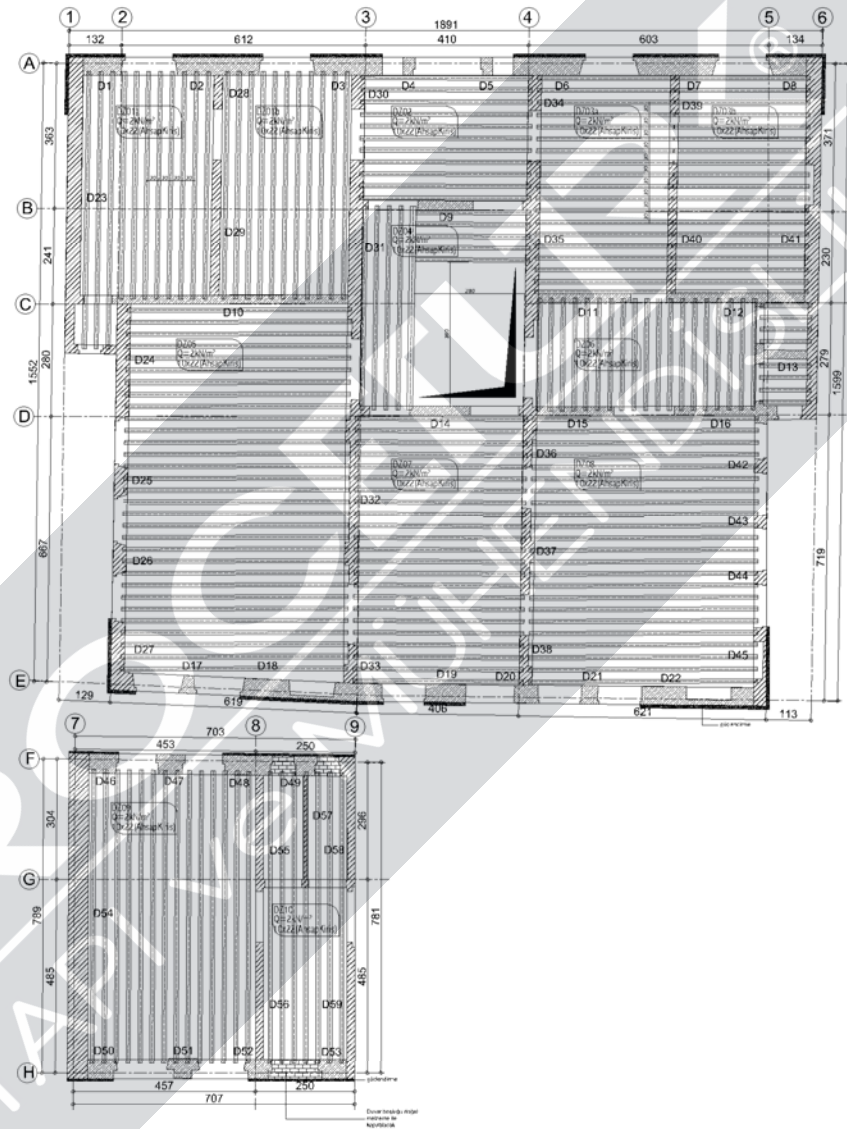

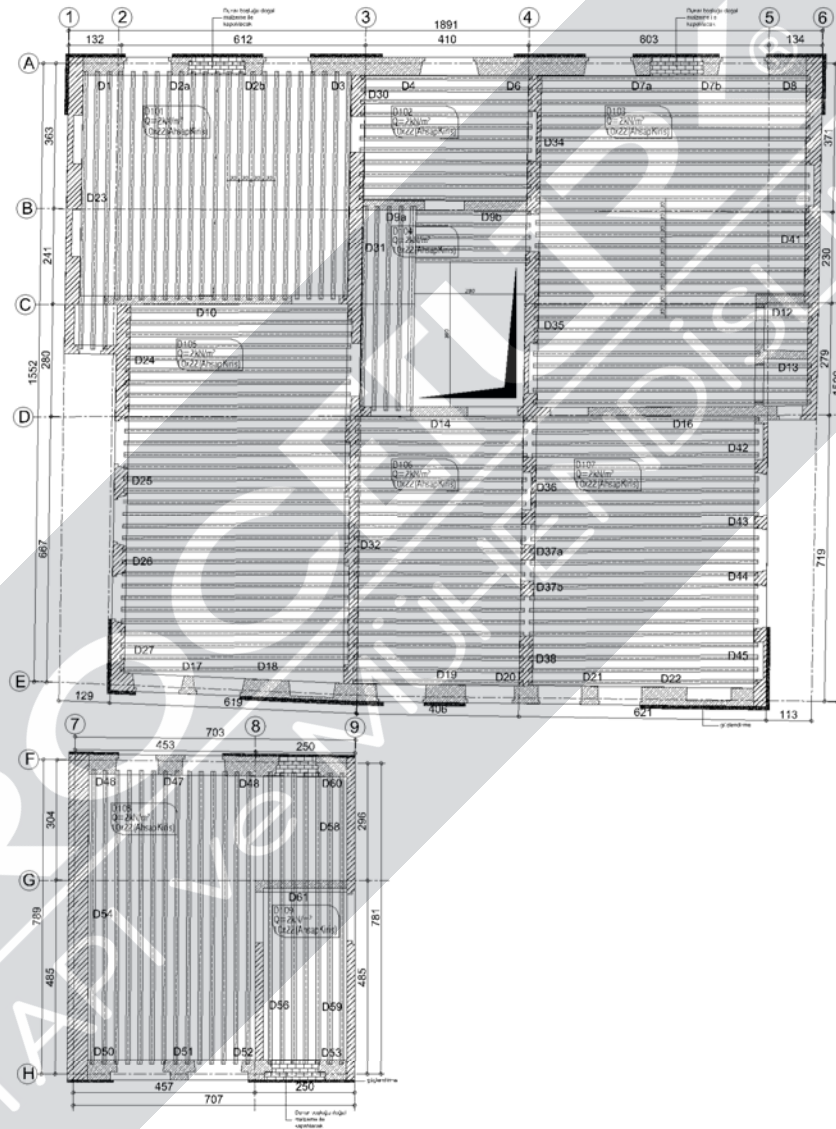

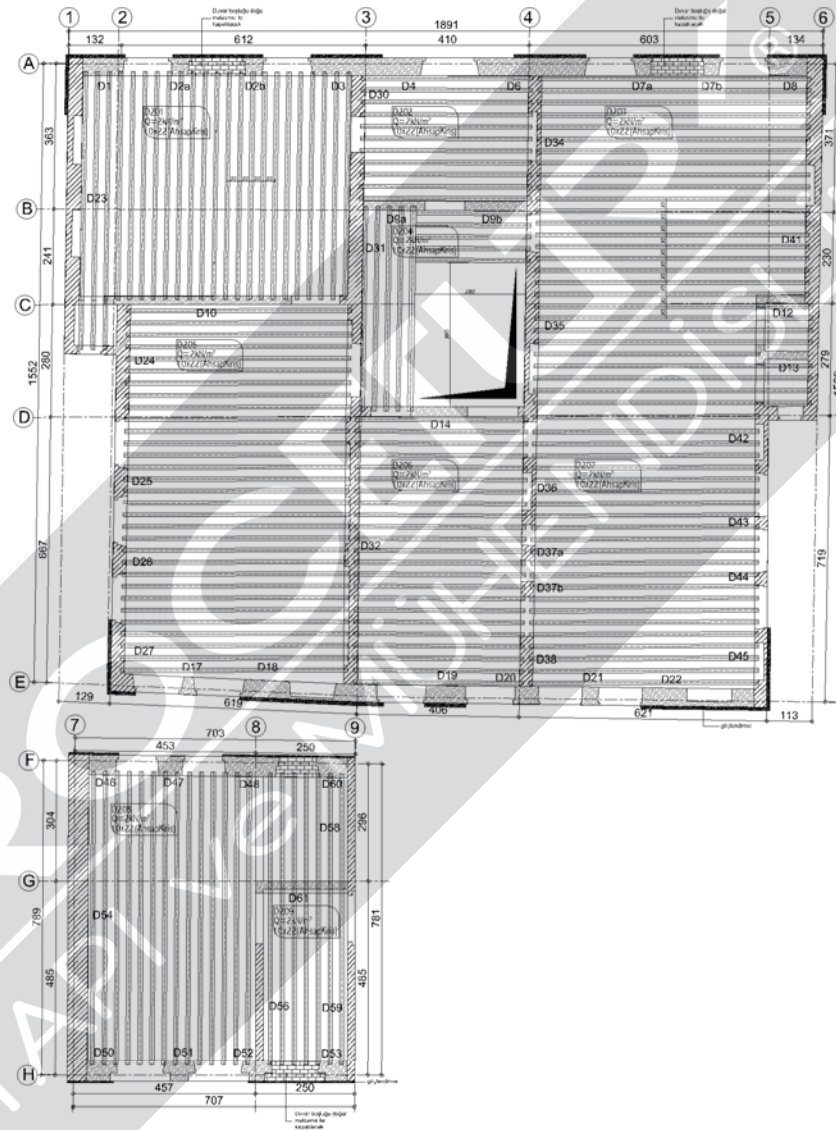



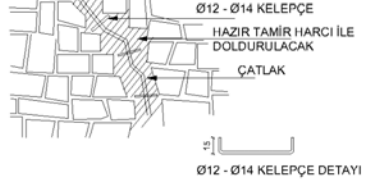

TAŞ DUVARDA ÇATLAK ONARIMI

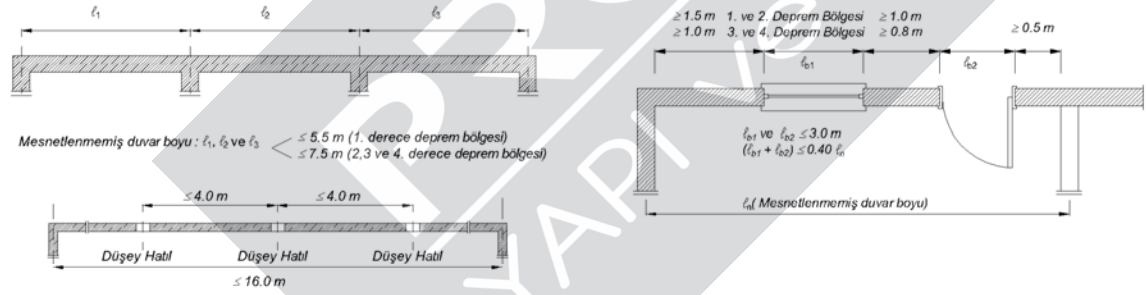
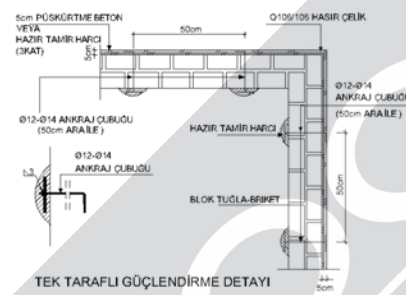
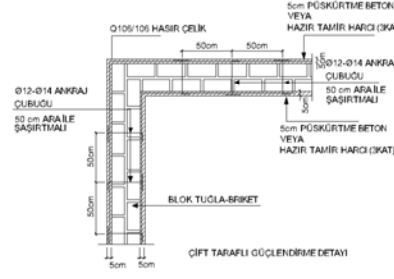
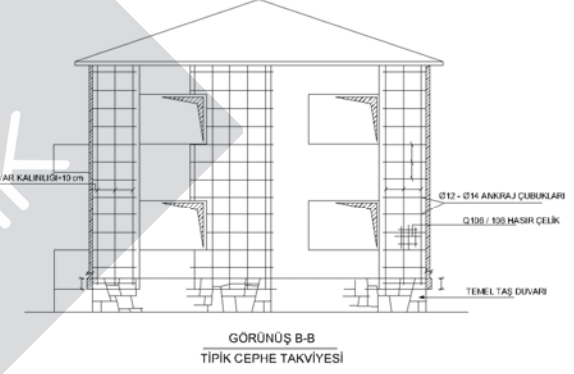
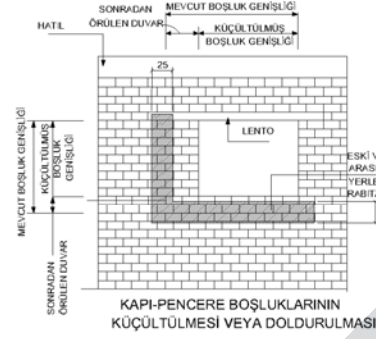

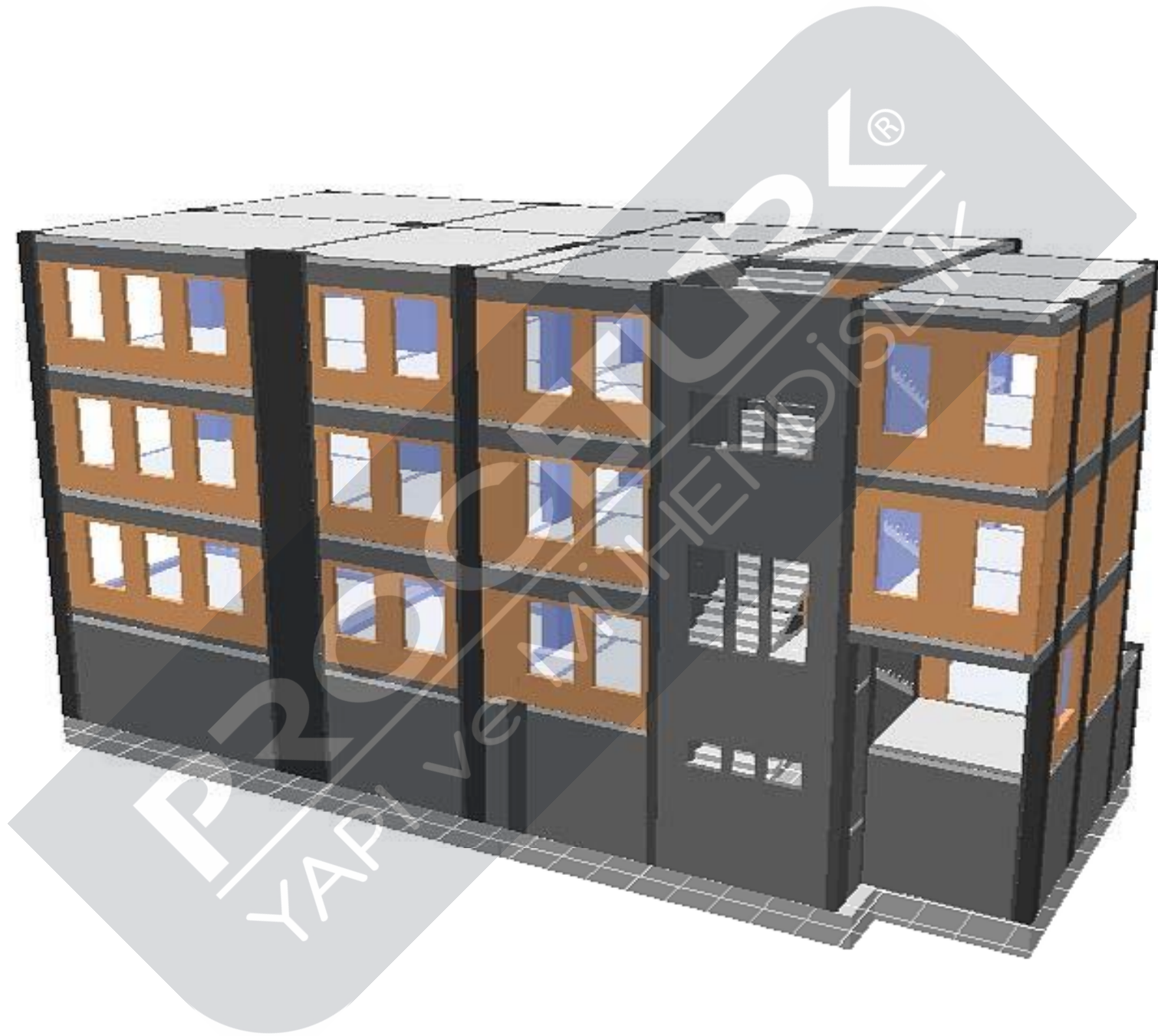

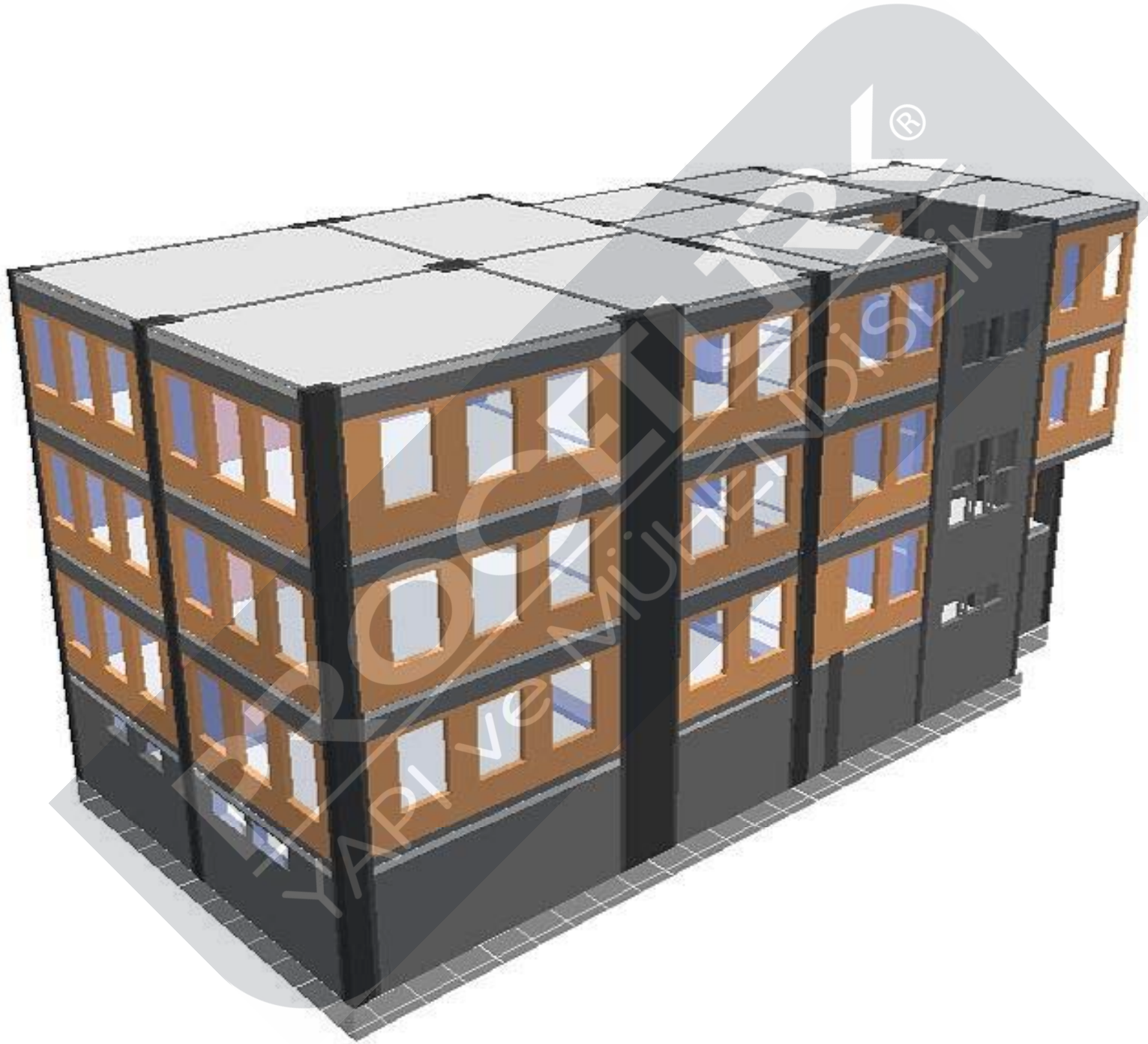



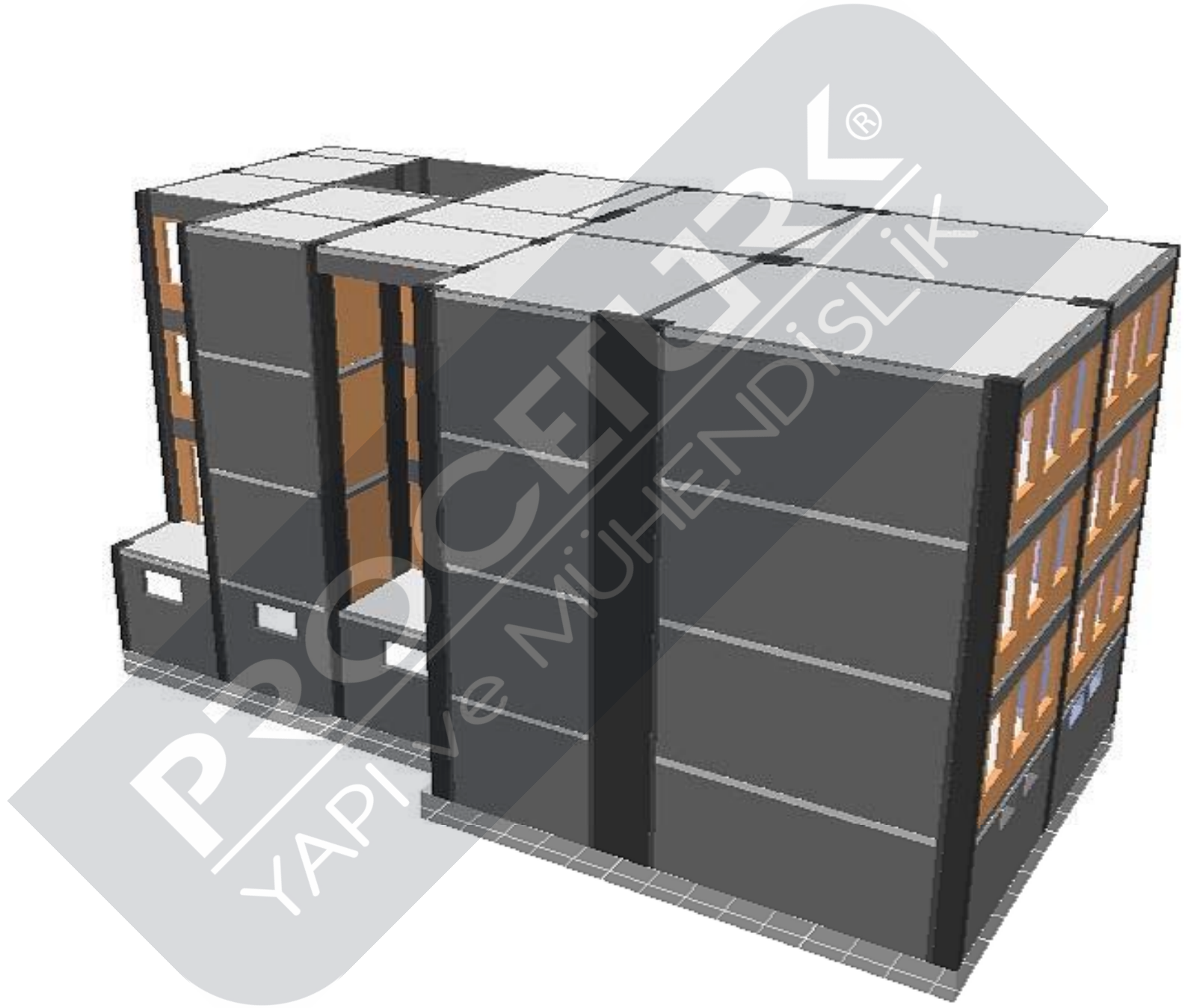



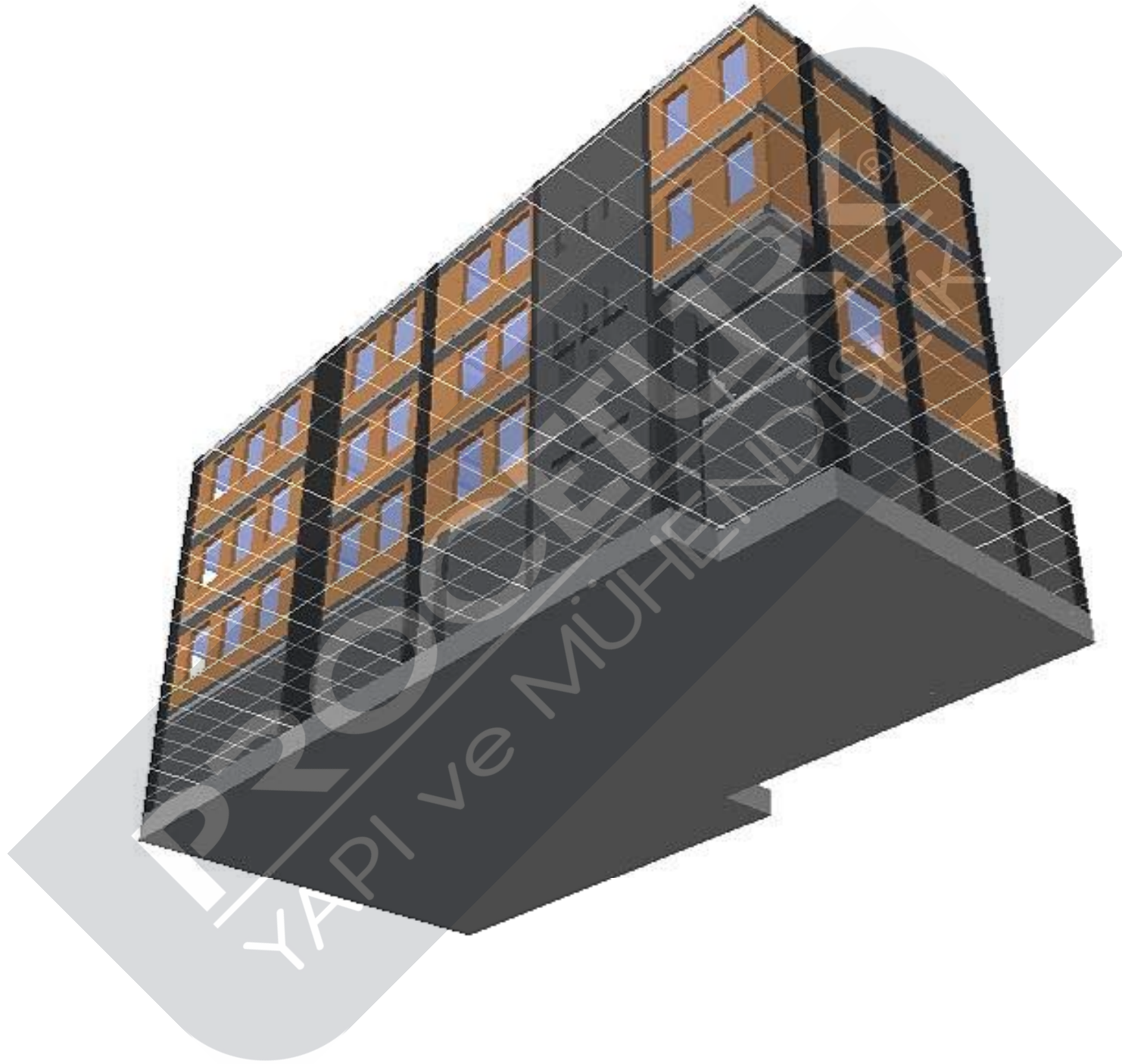









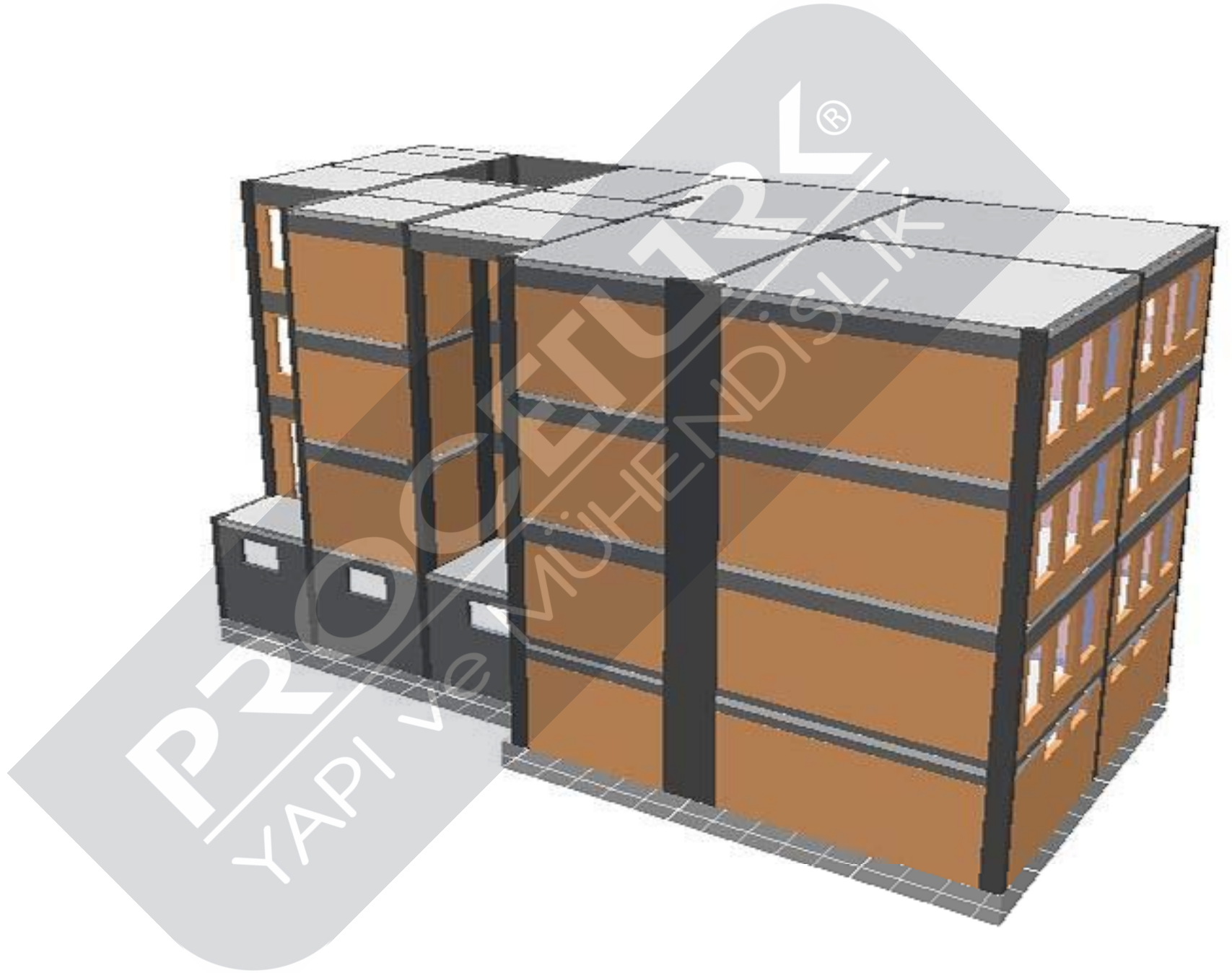



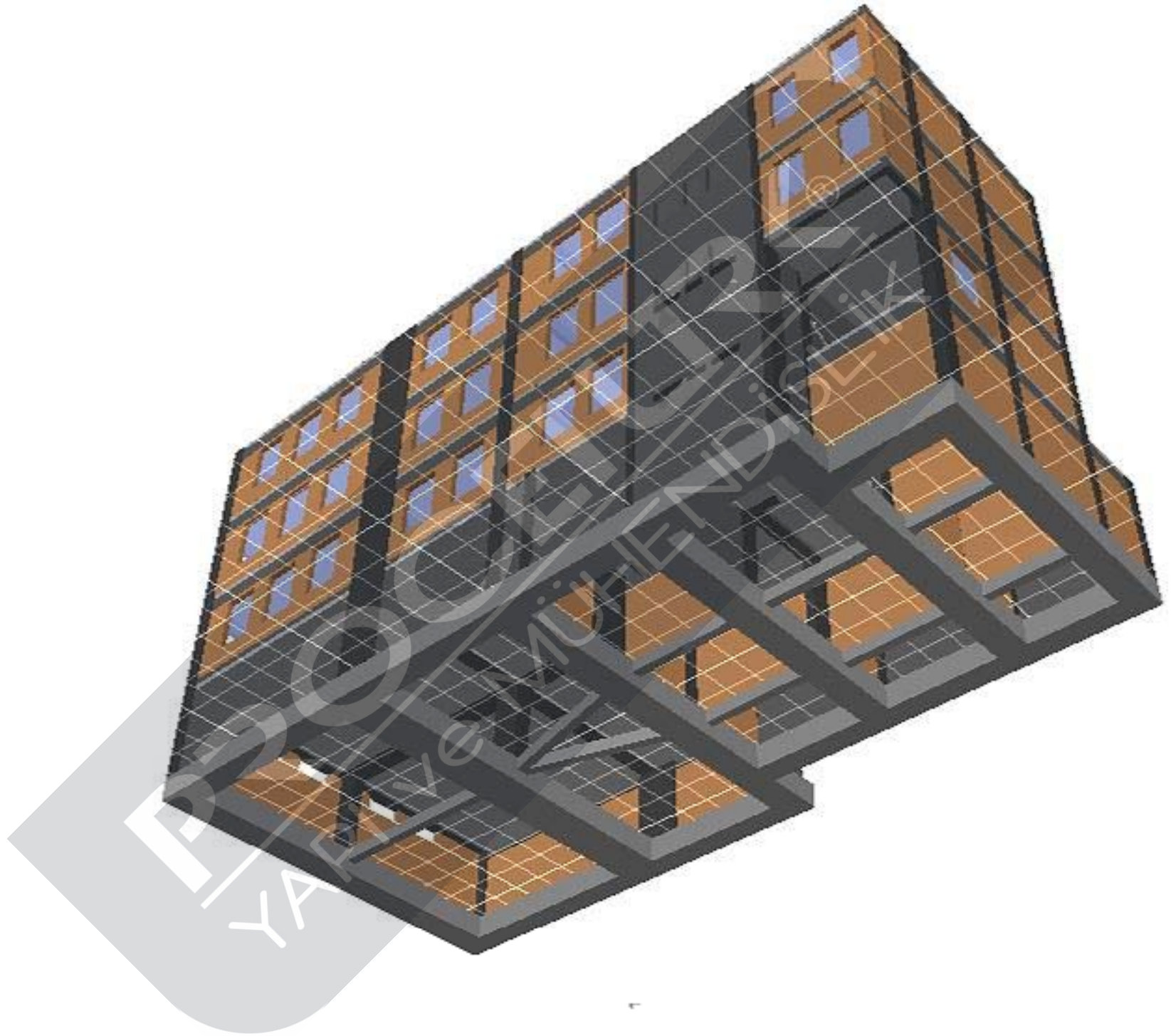



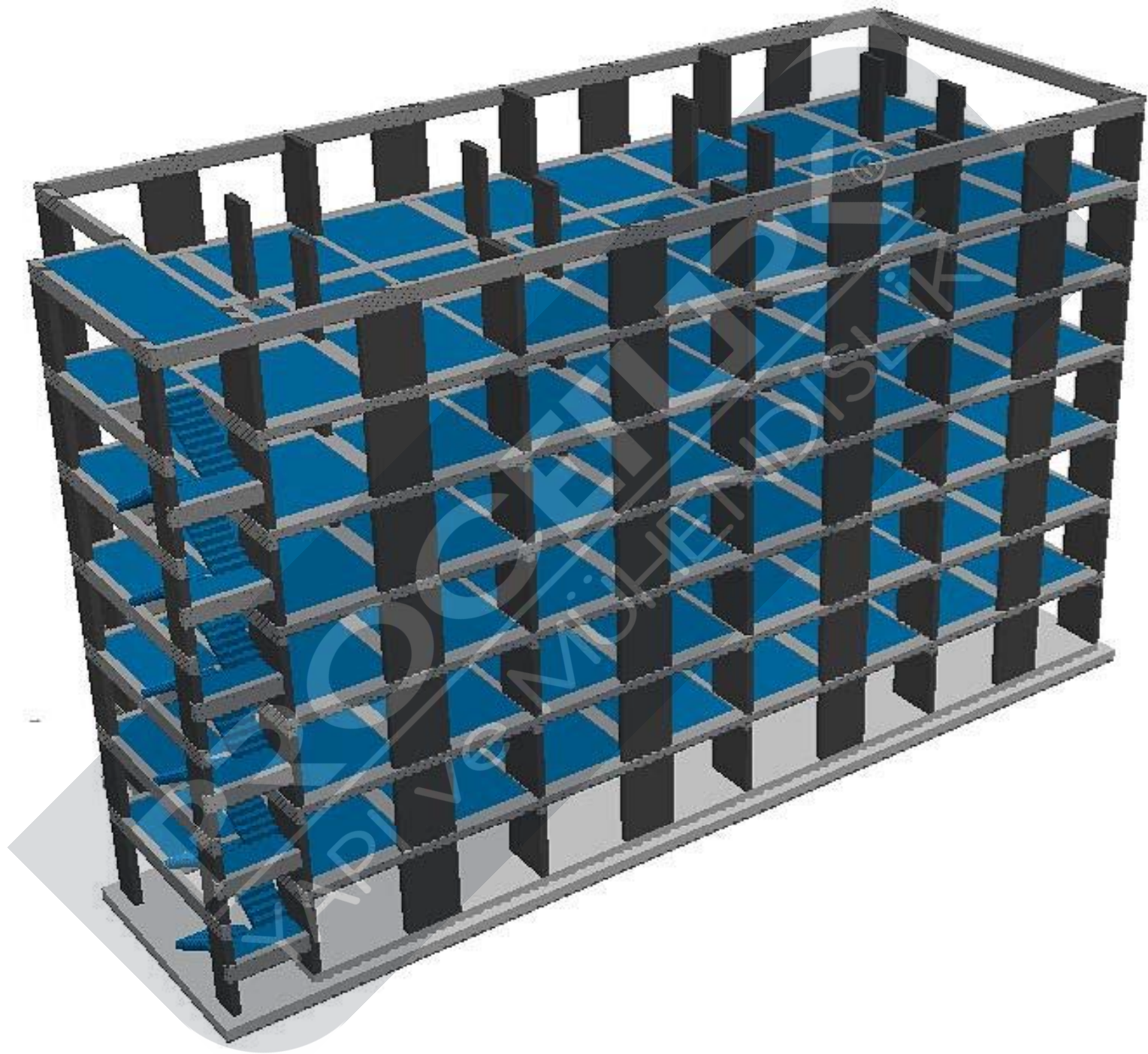

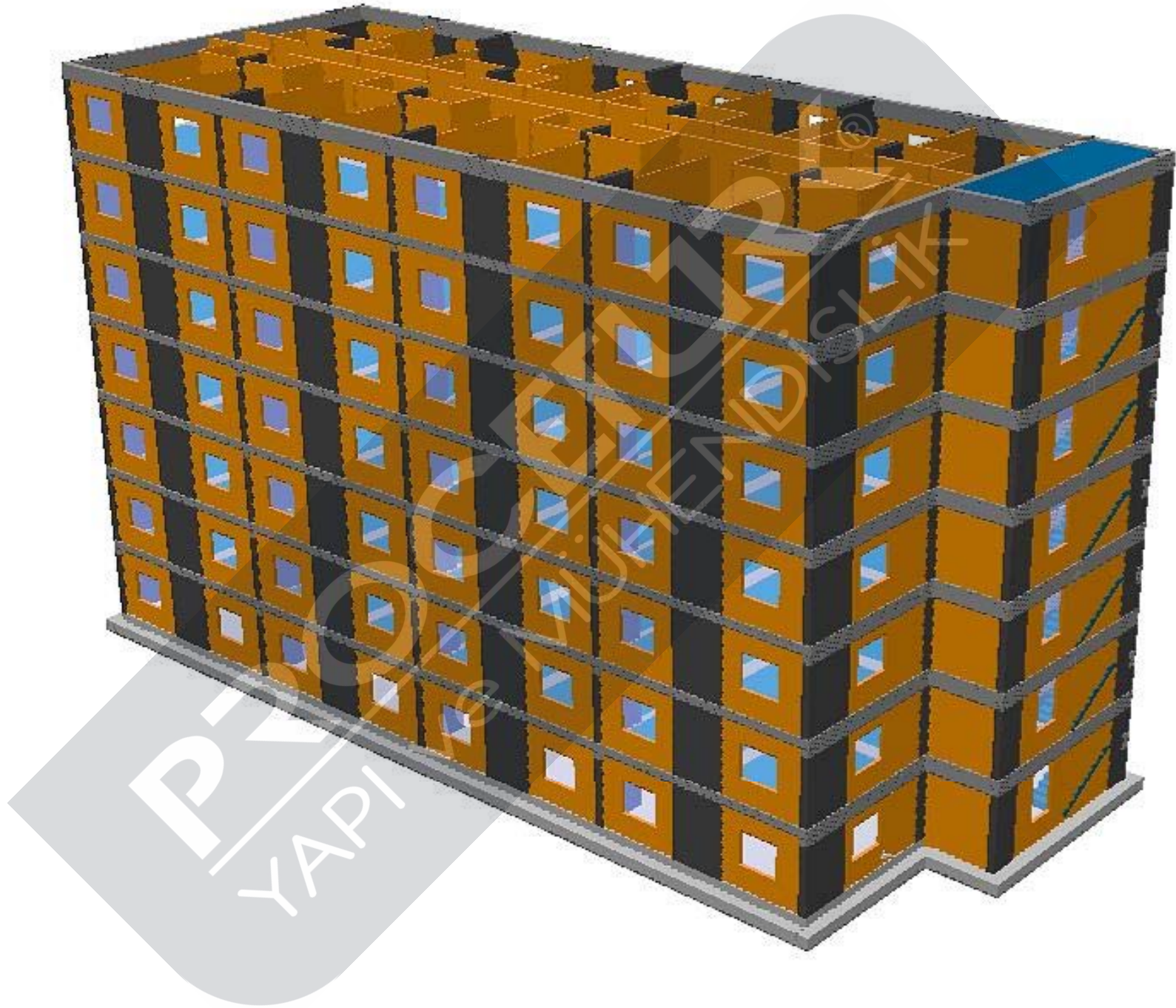



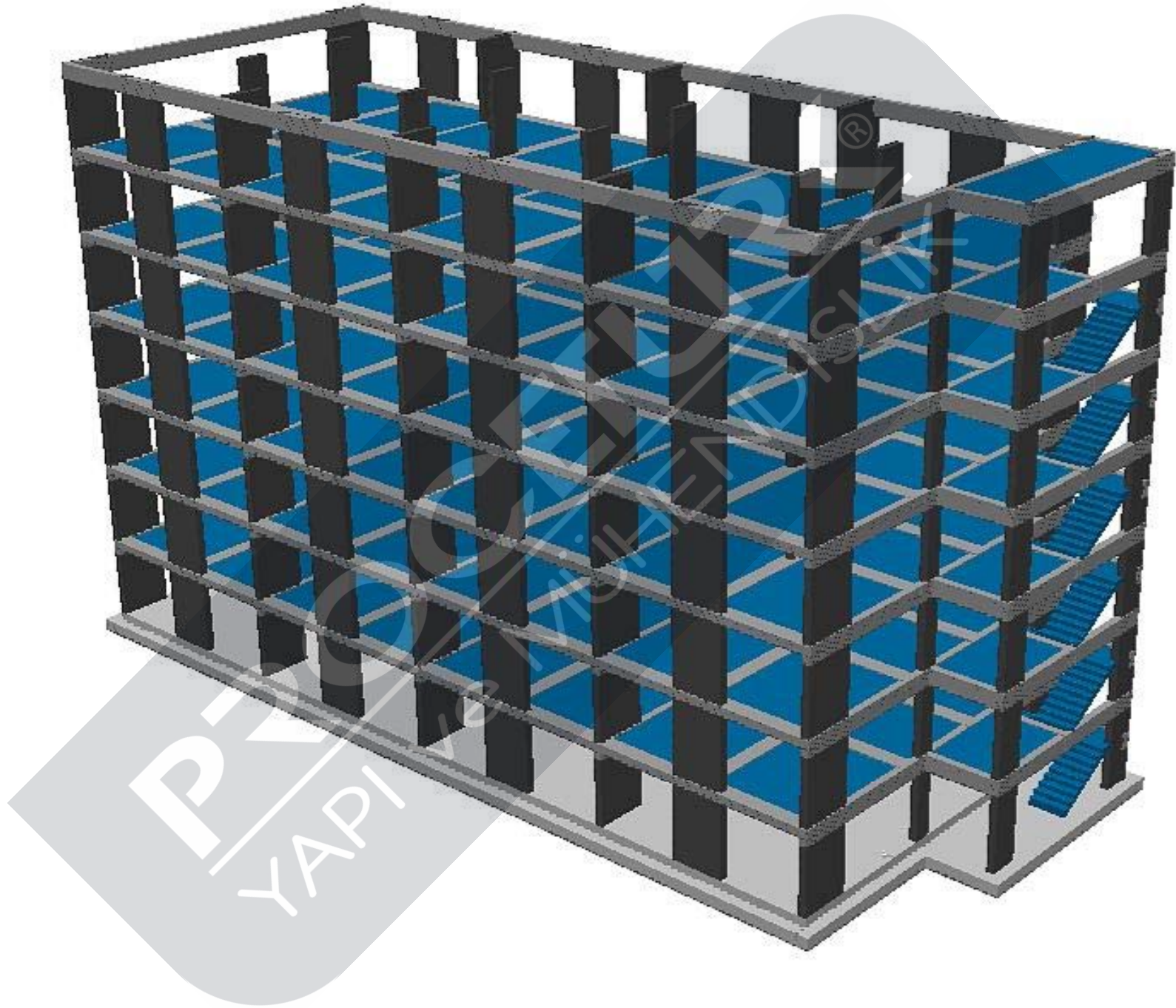

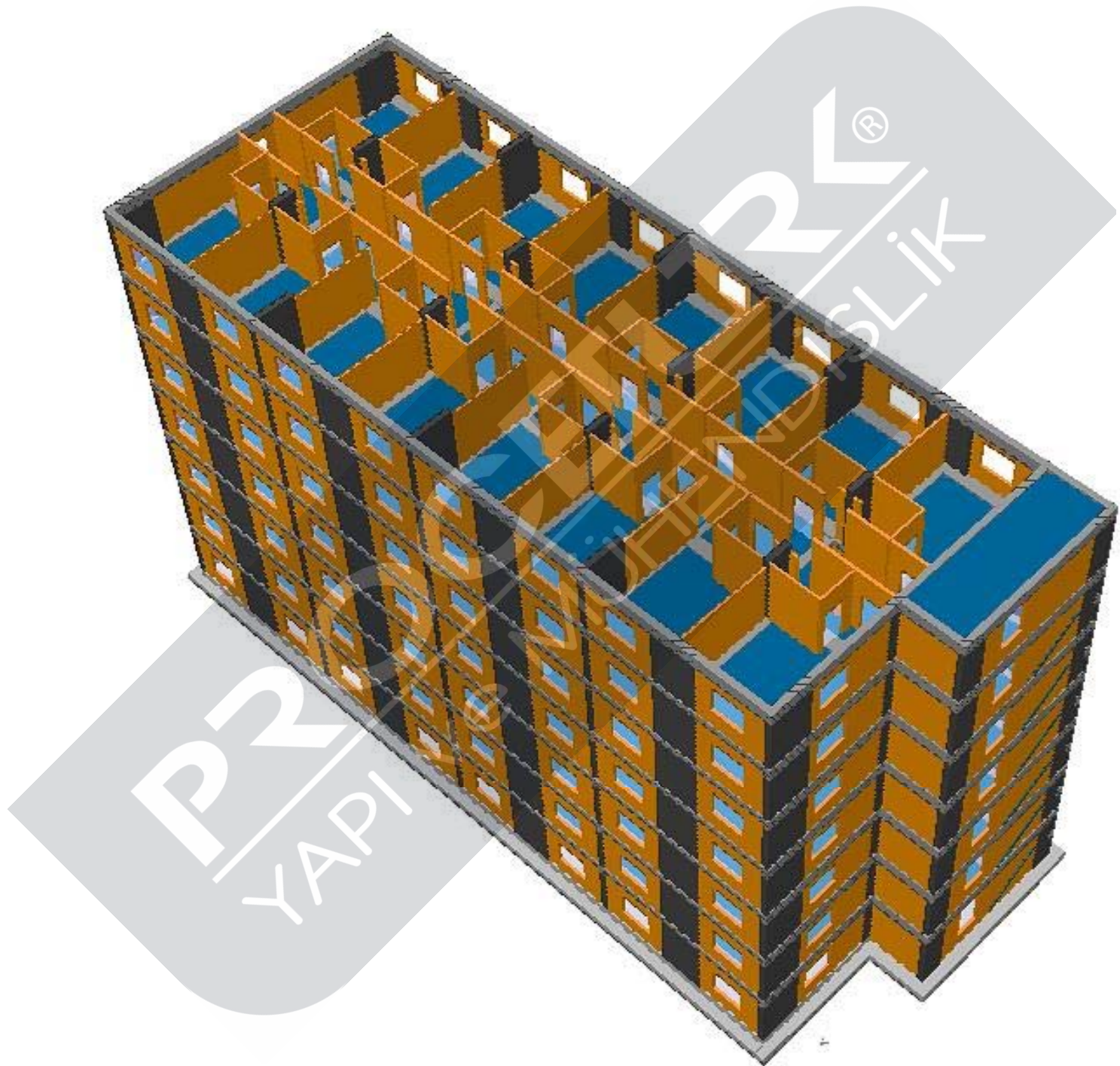

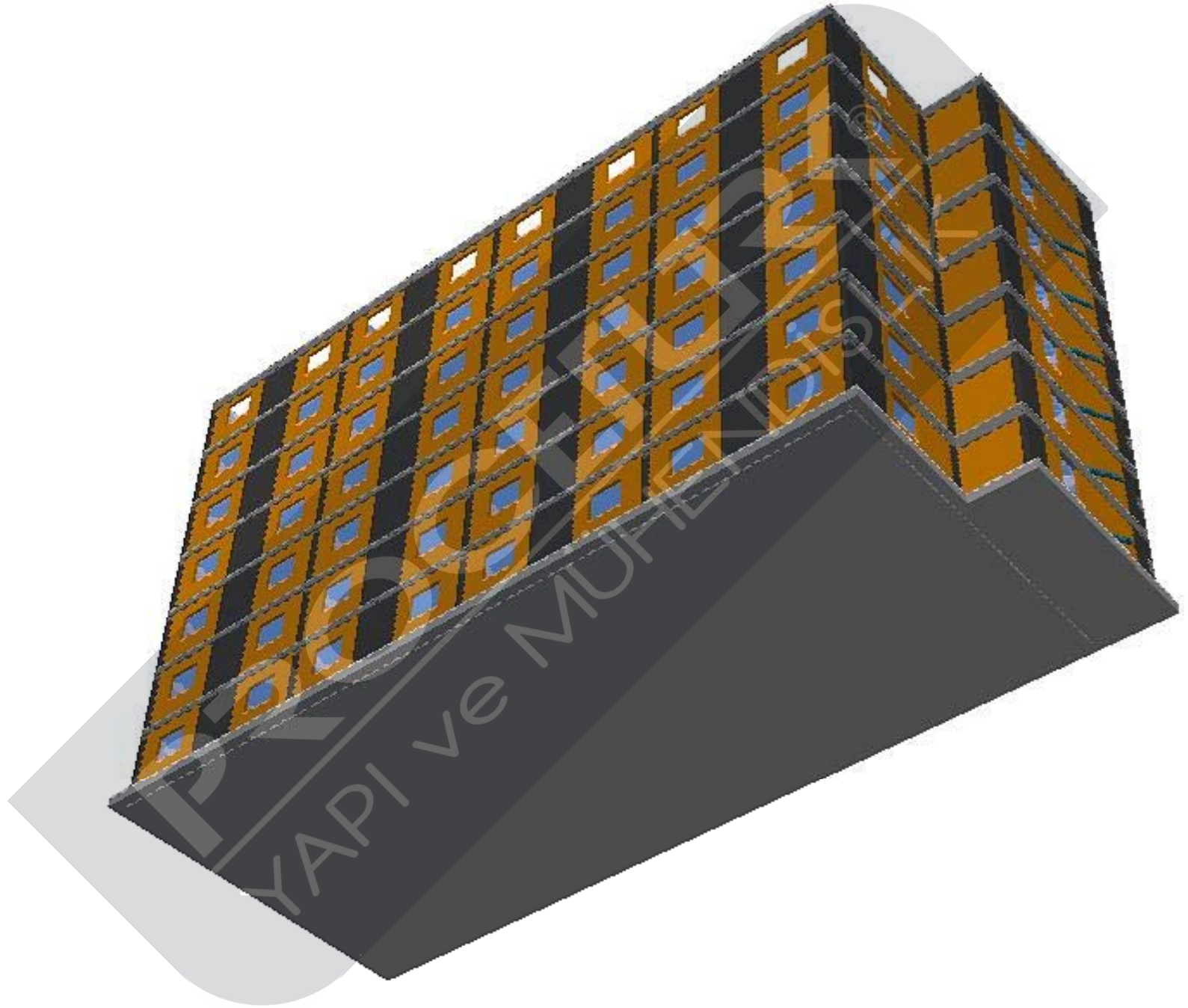



**ÇAĞIŞ**  
**ÖĞRENCİ YAŞAM MERKEZİ**  
YAT. İŞLT. TUR. İNŞ. TİC. A. Ş.

KADIKÖY Dİ. İKADENİZİ 243 80 50  
ADA CAFE 244 33 81

KADIKÖY Dİ. İKADENİZİ 243 80 50  
ADA CAFE 244 33 81











