

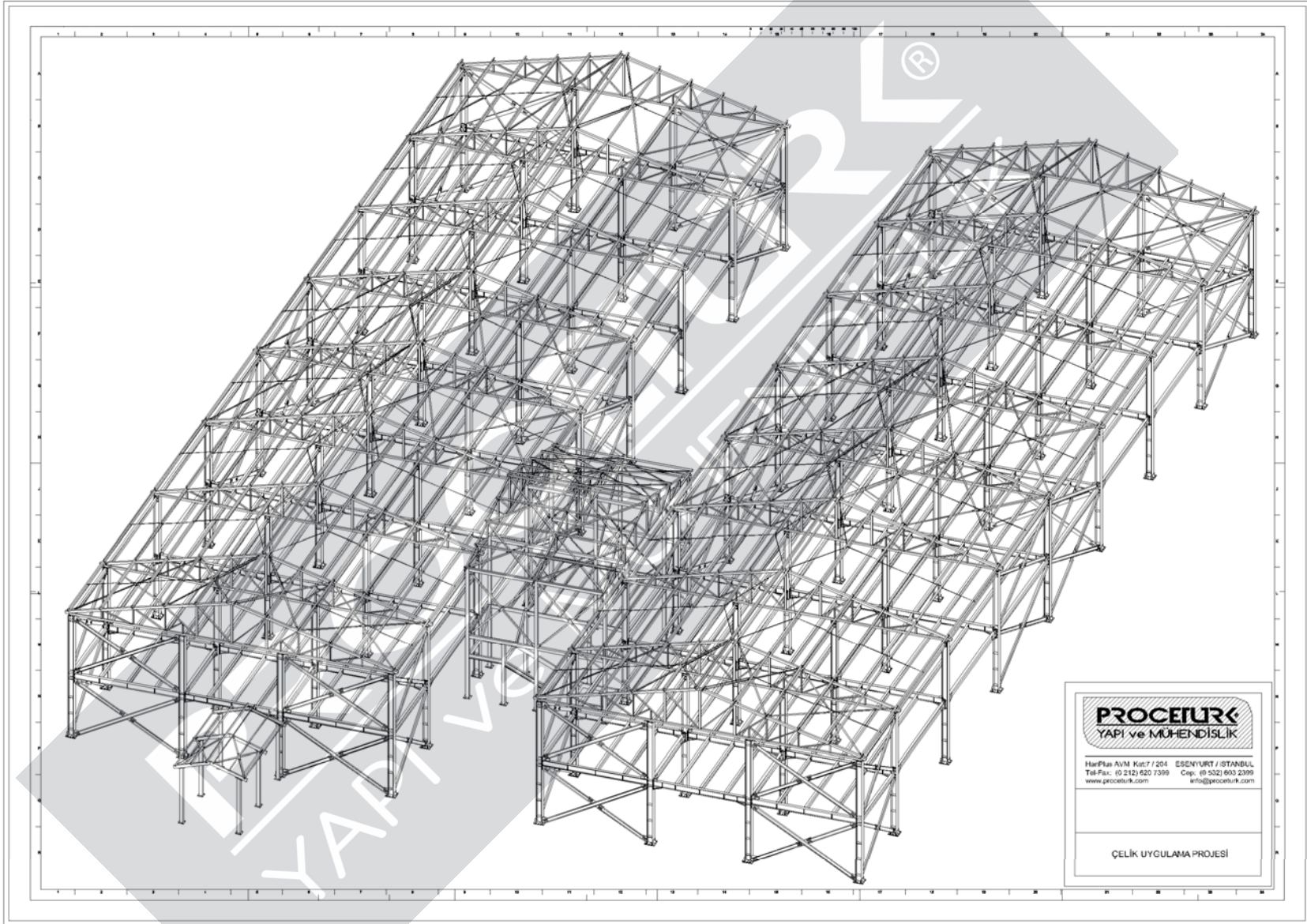

**Hastaneler**

**Hospitals**



**PROCELURK**  
YAPI ve MÜHENDİSLİK

Harfliler Alım Kat:7 / 204 ESENÜRT / İSTANBUL  
Tel-Fax: (0 212) 620 7399 Csp: (0 552) 603 2399  
www.procelurk.com info@procelurk.com

ÇELİK UYGULAMA PROJESİ

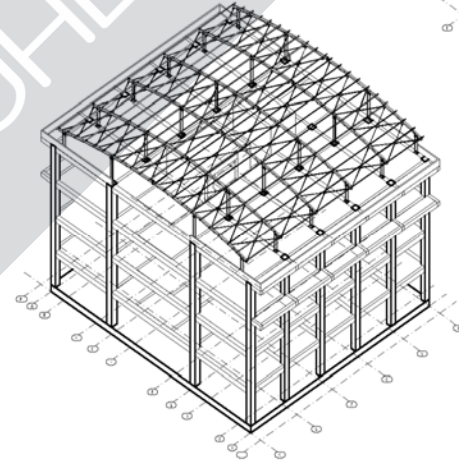
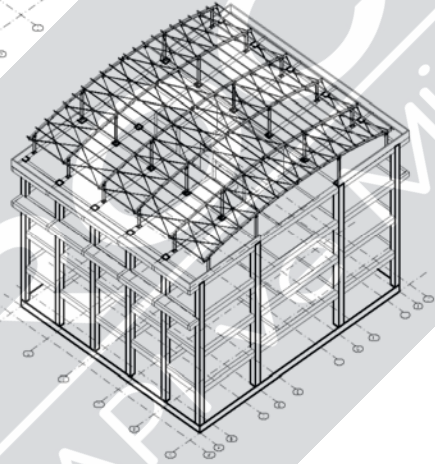
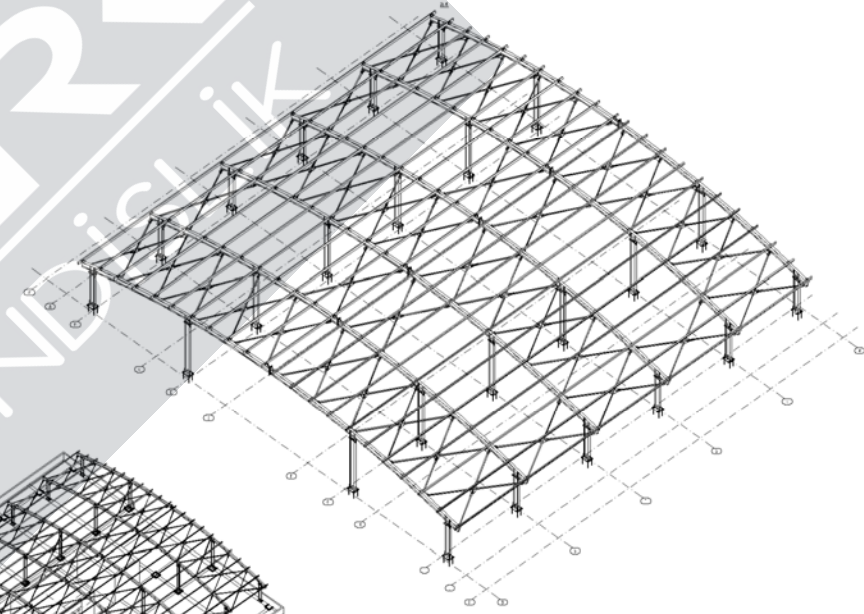
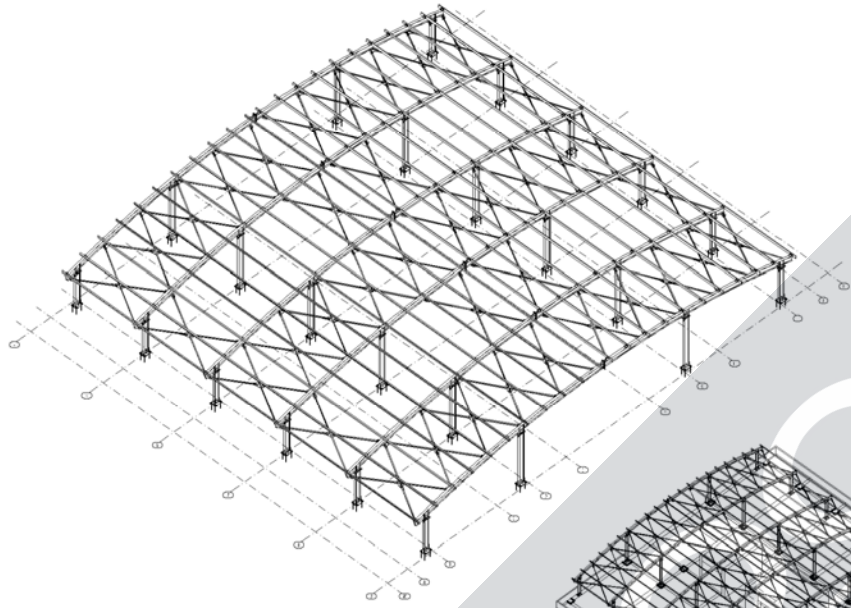

PT. YAFER ENGINEERING®

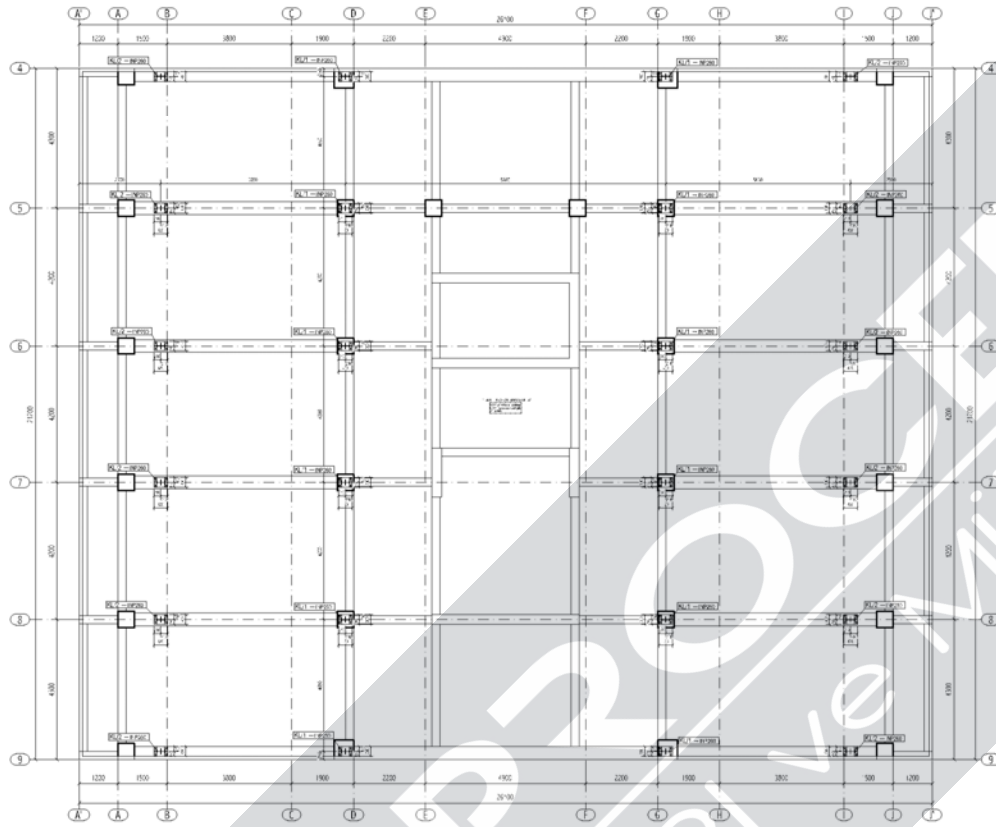

CATI KATI İNÖN APLİKASYON PLANI (1/50)-(11/25)

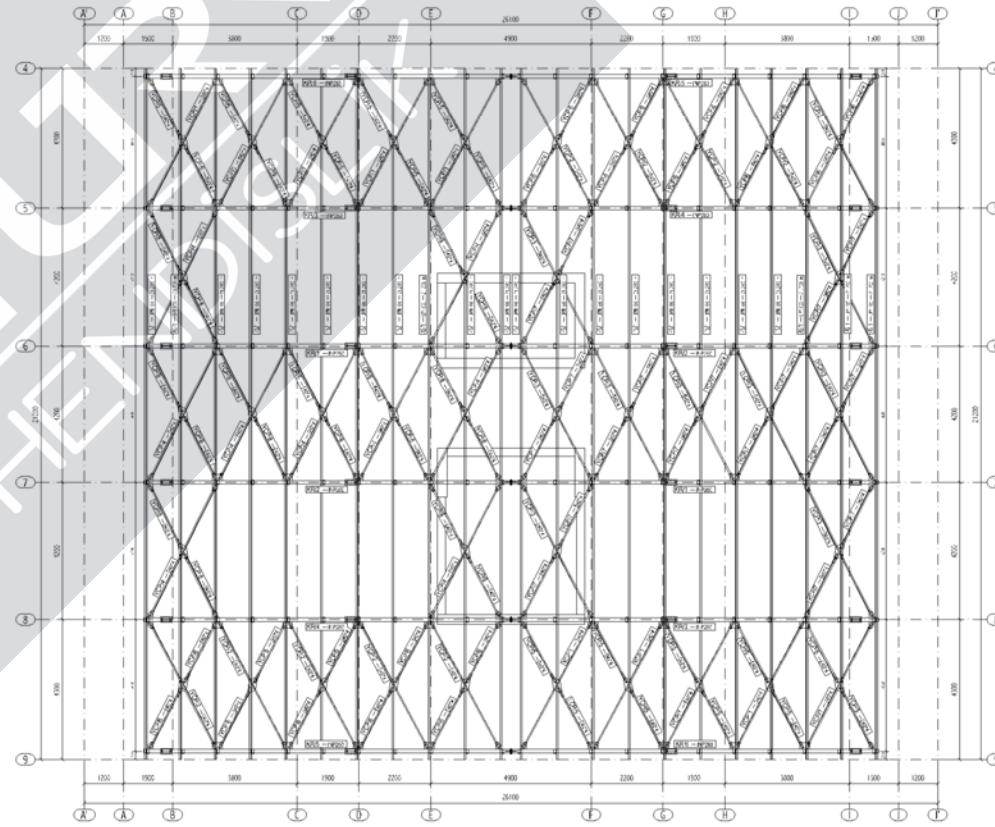

5.ETEN GÖRÜNÜŞİ (1/50)



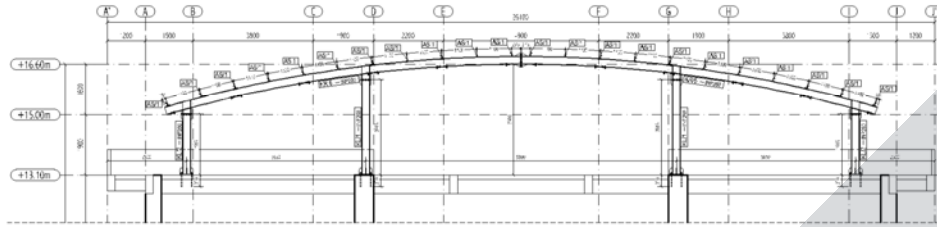

"4-4" AKSI KEŞİT GÖRÜNÜŞÜ (1/50)

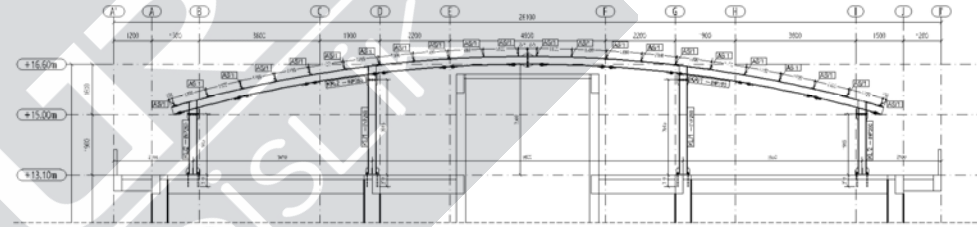

"7-7" AKSI KEŞİT GÖRÜNÜŞÜ (1/50)

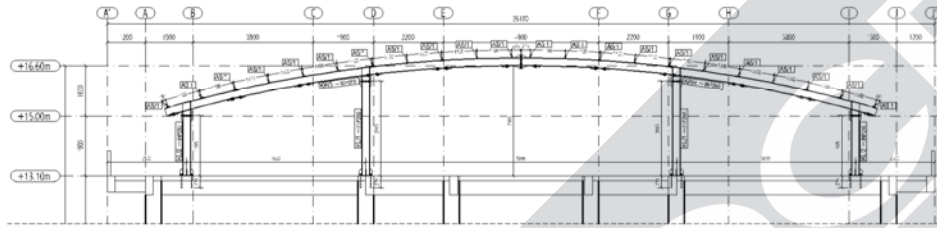

"5-5" AKSI KEŞİT GÖRÜNÜŞÜ (1/50)

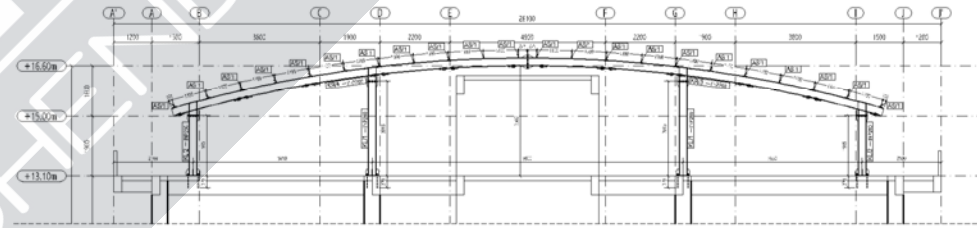

"8-8" AKSI KEŞİT GÖRÜNÜŞÜ (1/50)

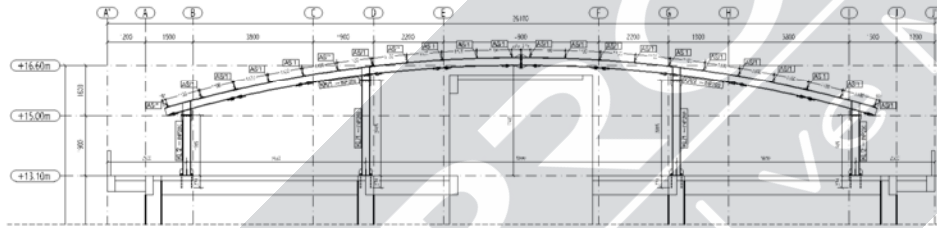

"6-6" AKSI KEŞİT GÖRÜNÜŞÜ (1/50)

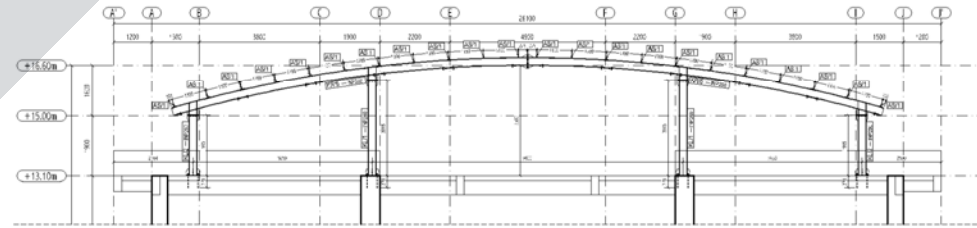

"9-9" AKSI KEŞİT GÖRÜNÜŞÜ (1/50)

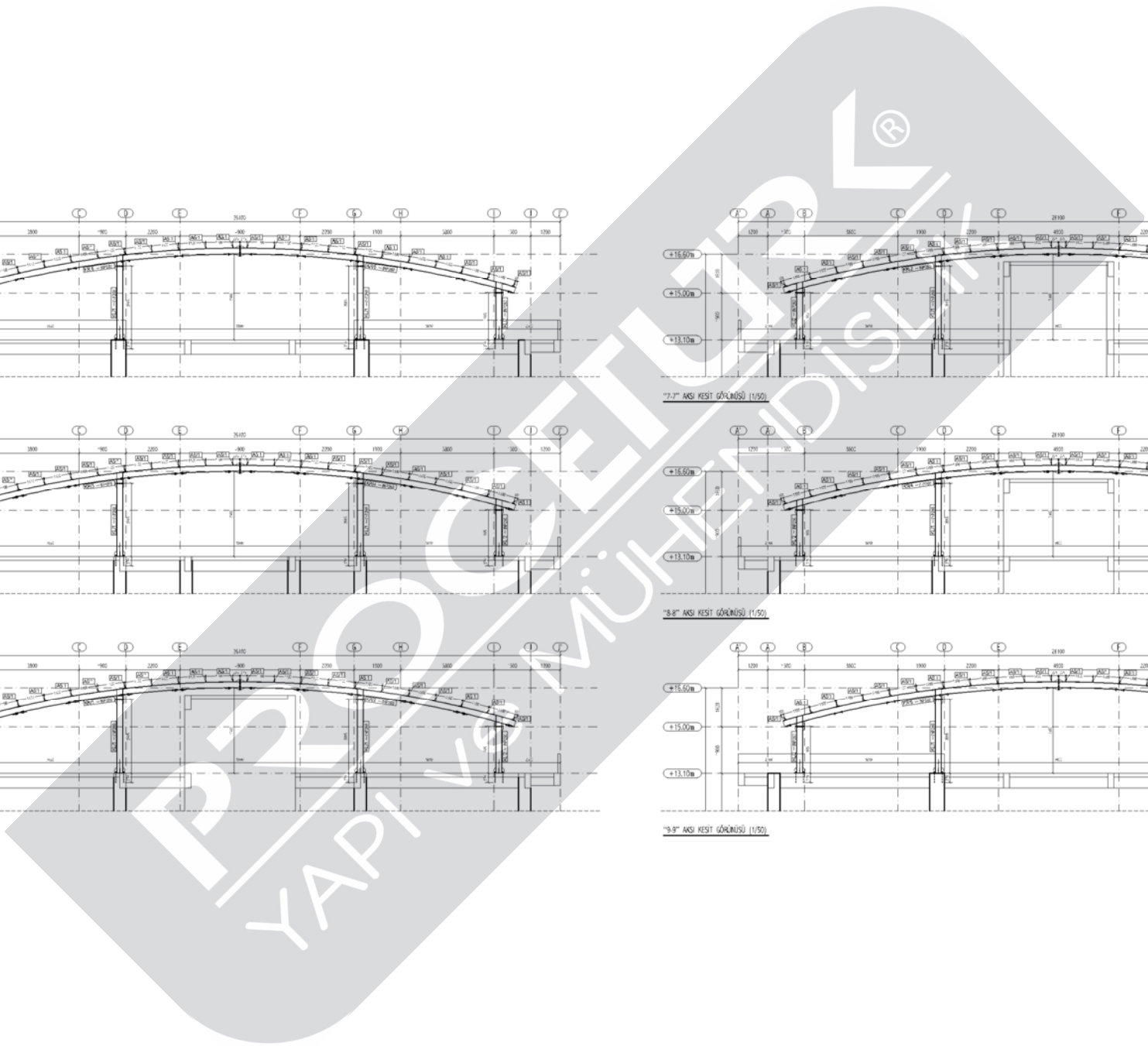

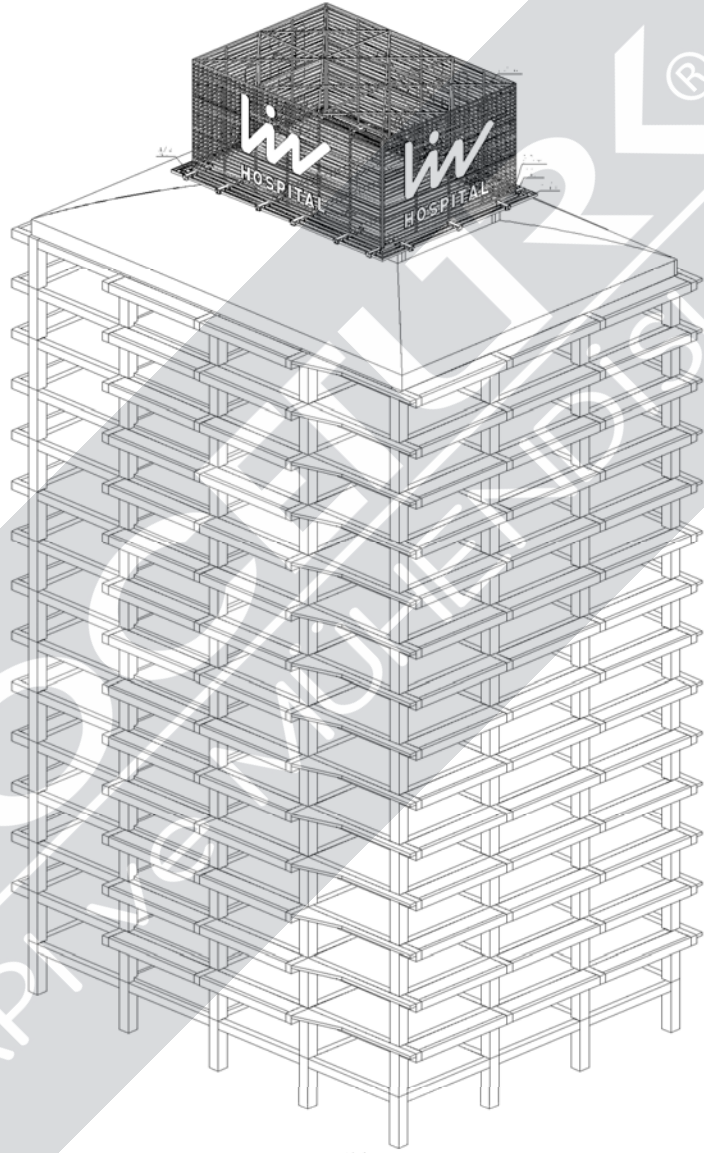

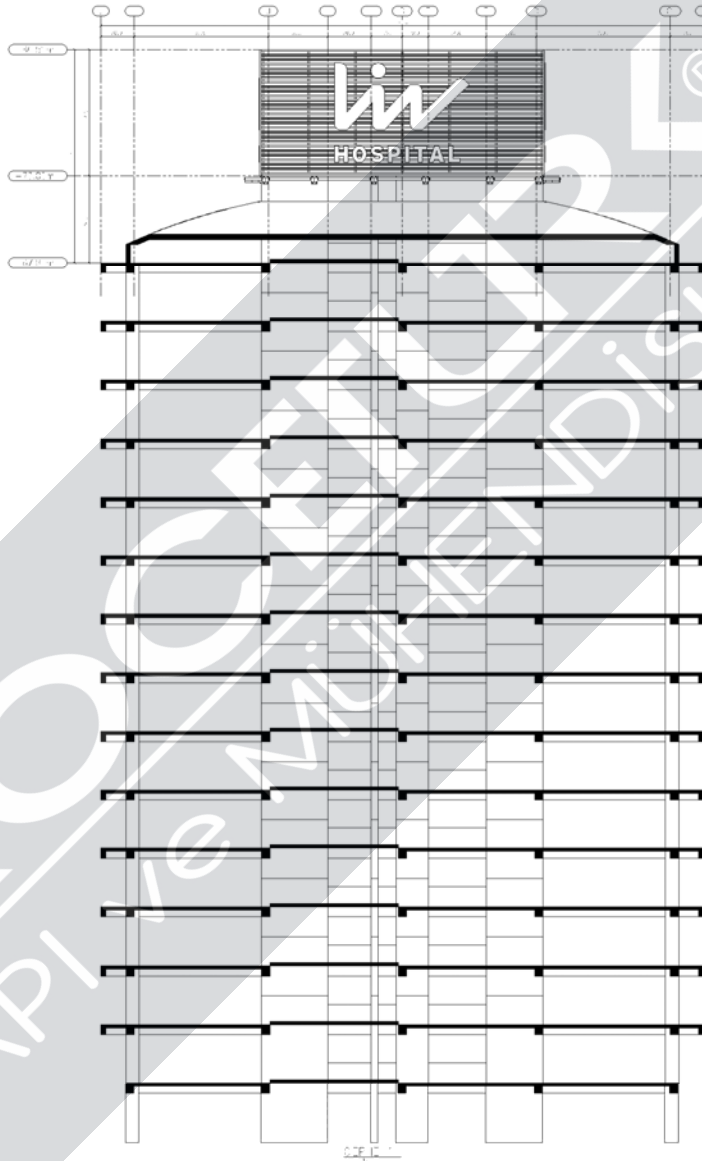

PRO  
YAPI VE MÜHÜRendislik

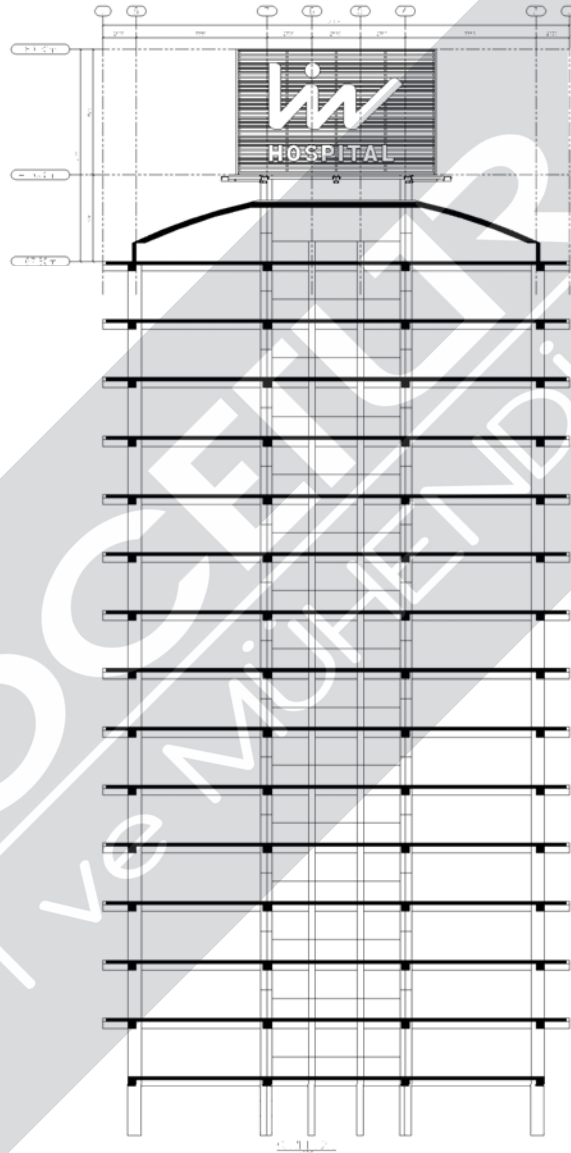

PROJE VE MÜHÜR BİRLİK



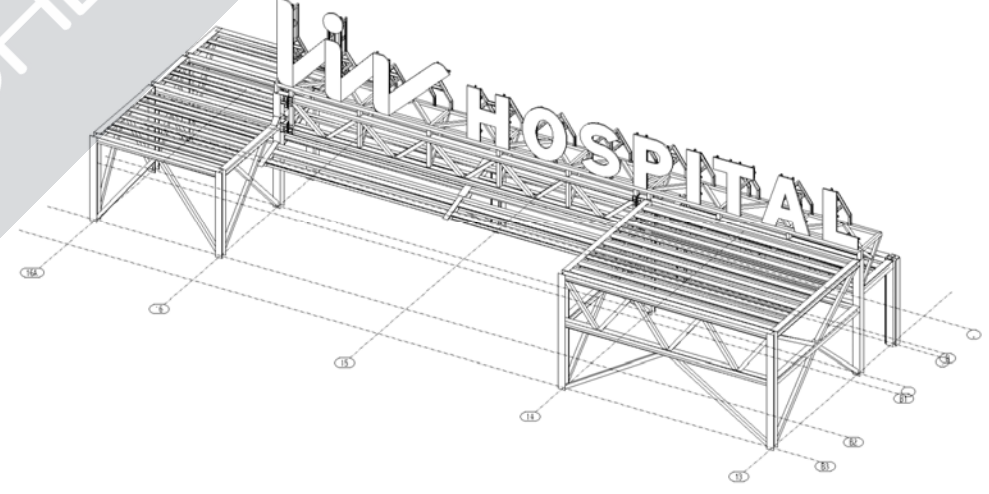
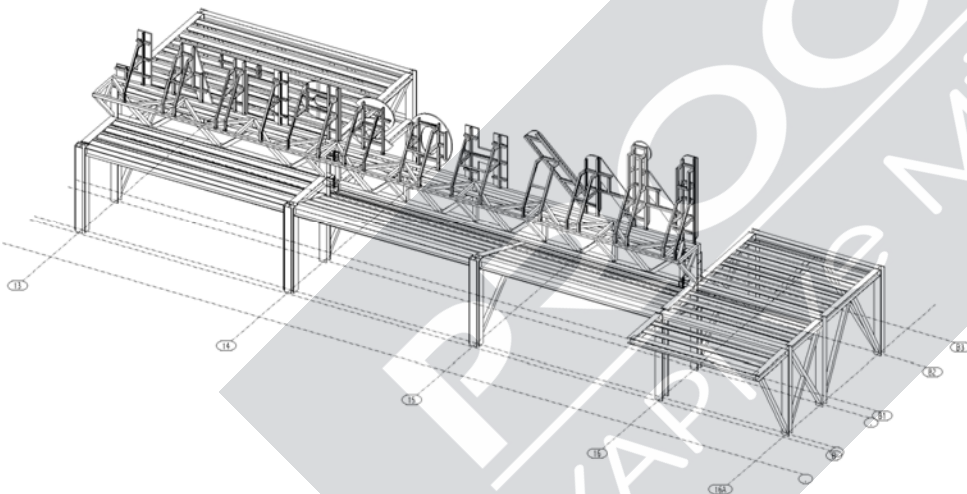
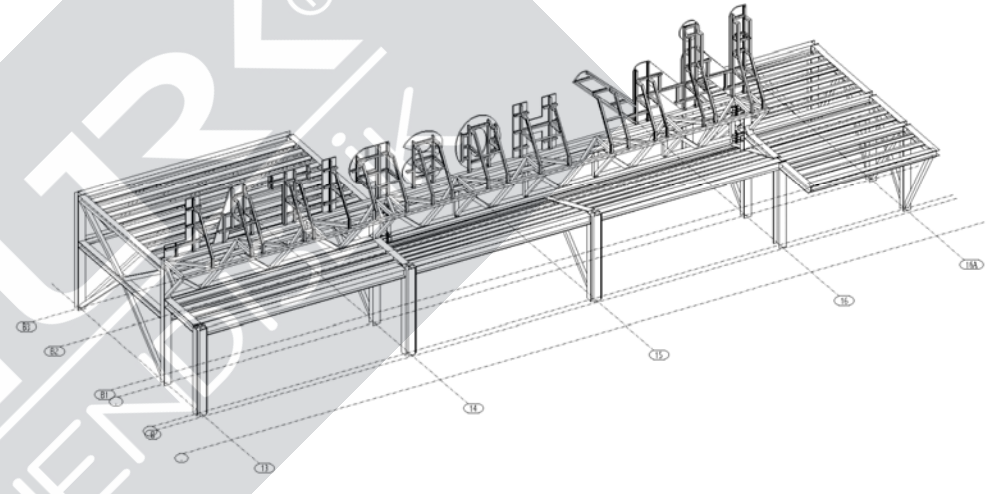
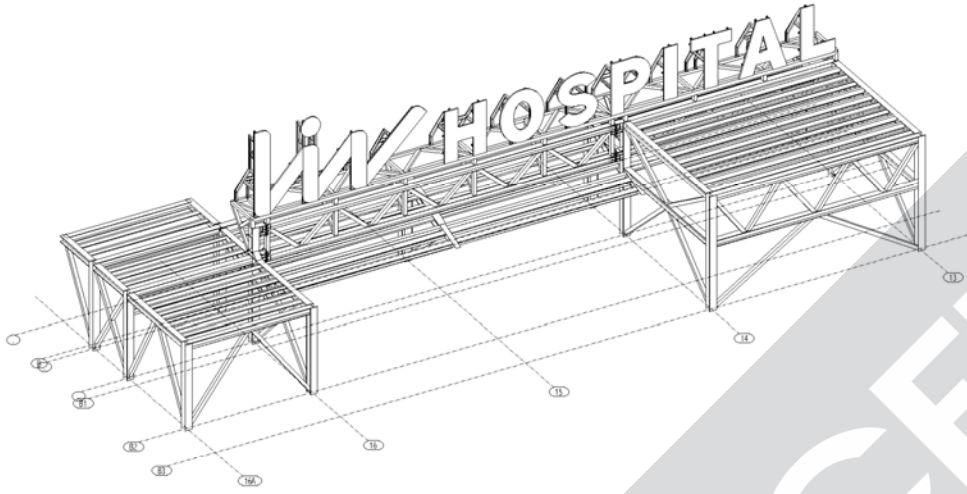

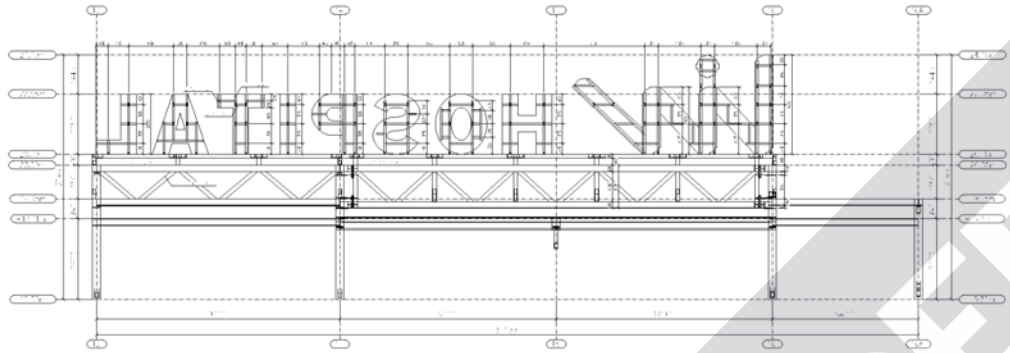

"11" AKSI KEŞİT ÇERÇEVESİ (1/50)

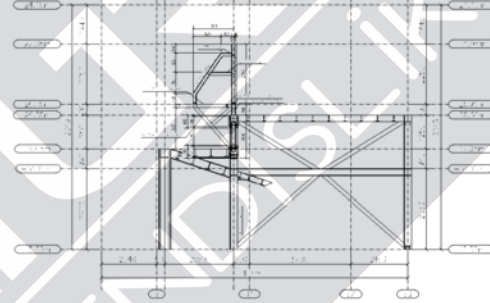

"12" AKSI KEŞİT ÇERÇEVESİ (1/50)

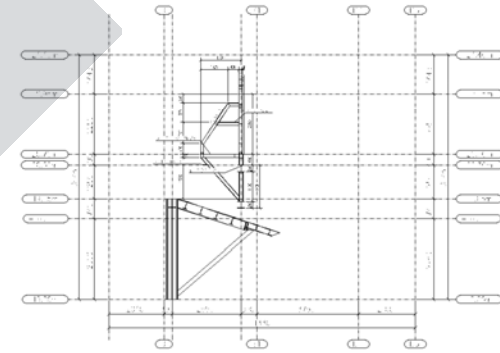

"13" AKSI KEŞİT ÇERÇEVESİ (1/50)

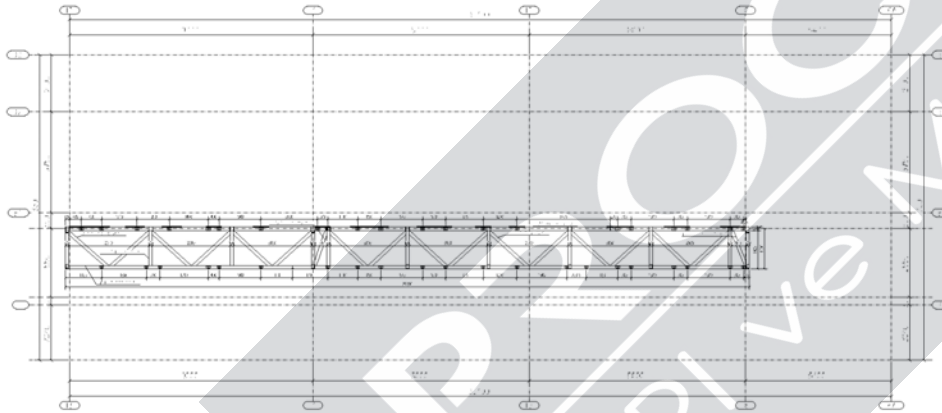

"20.20" NOTU PLANI (1/20)

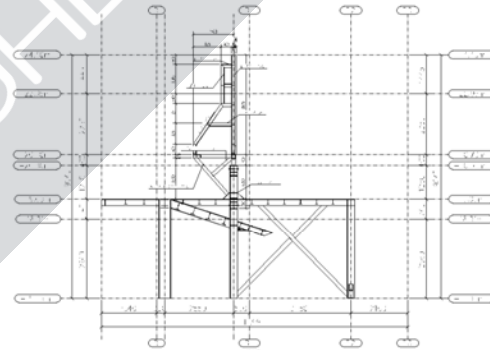

"15" AKSI KEŞİT ÇERÇEVESİ (1/50)

PROCELEST  
YAPI VE MÜHÜR

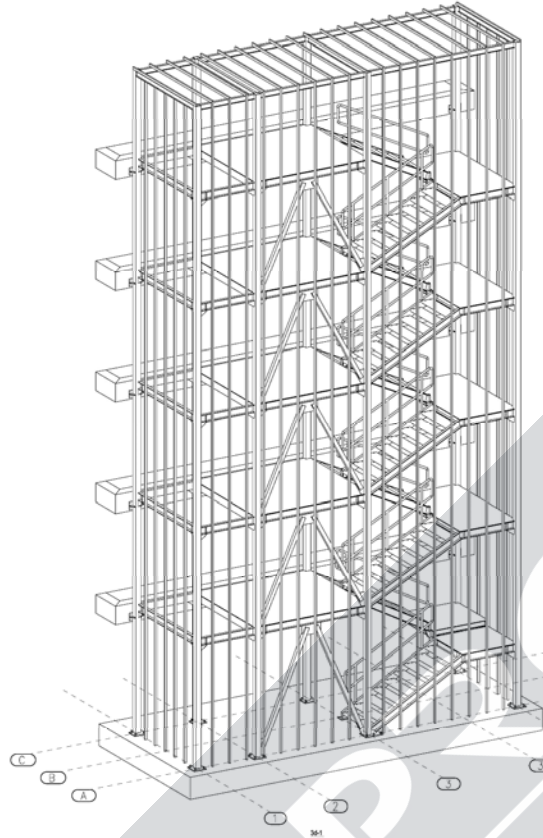

IZOMETRIK GORUNUS-1  
ÖLÇEK:1/50

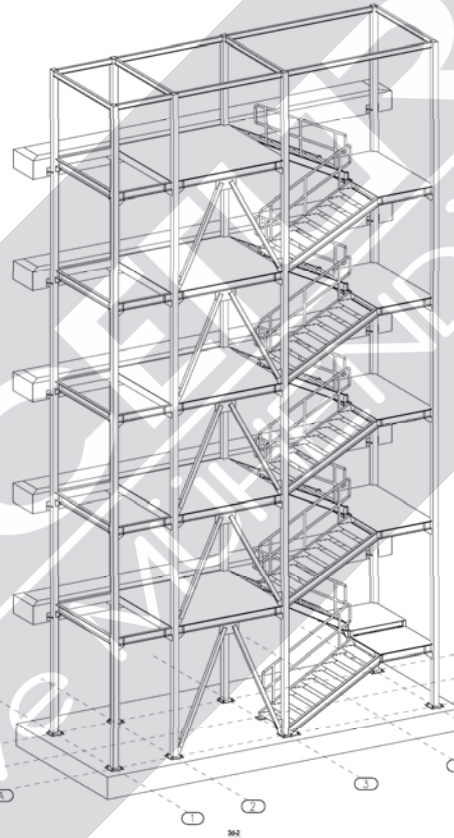

IZOMETRIK GORUNUS-2  
ÖLÇEK:1/50

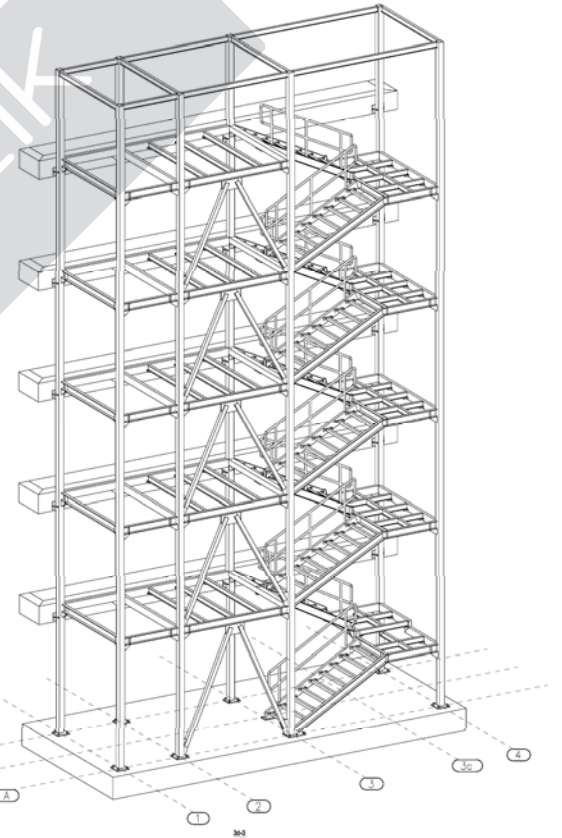

IZOMETRIK GORUNUS-3  
ÖLÇEK:1/50