

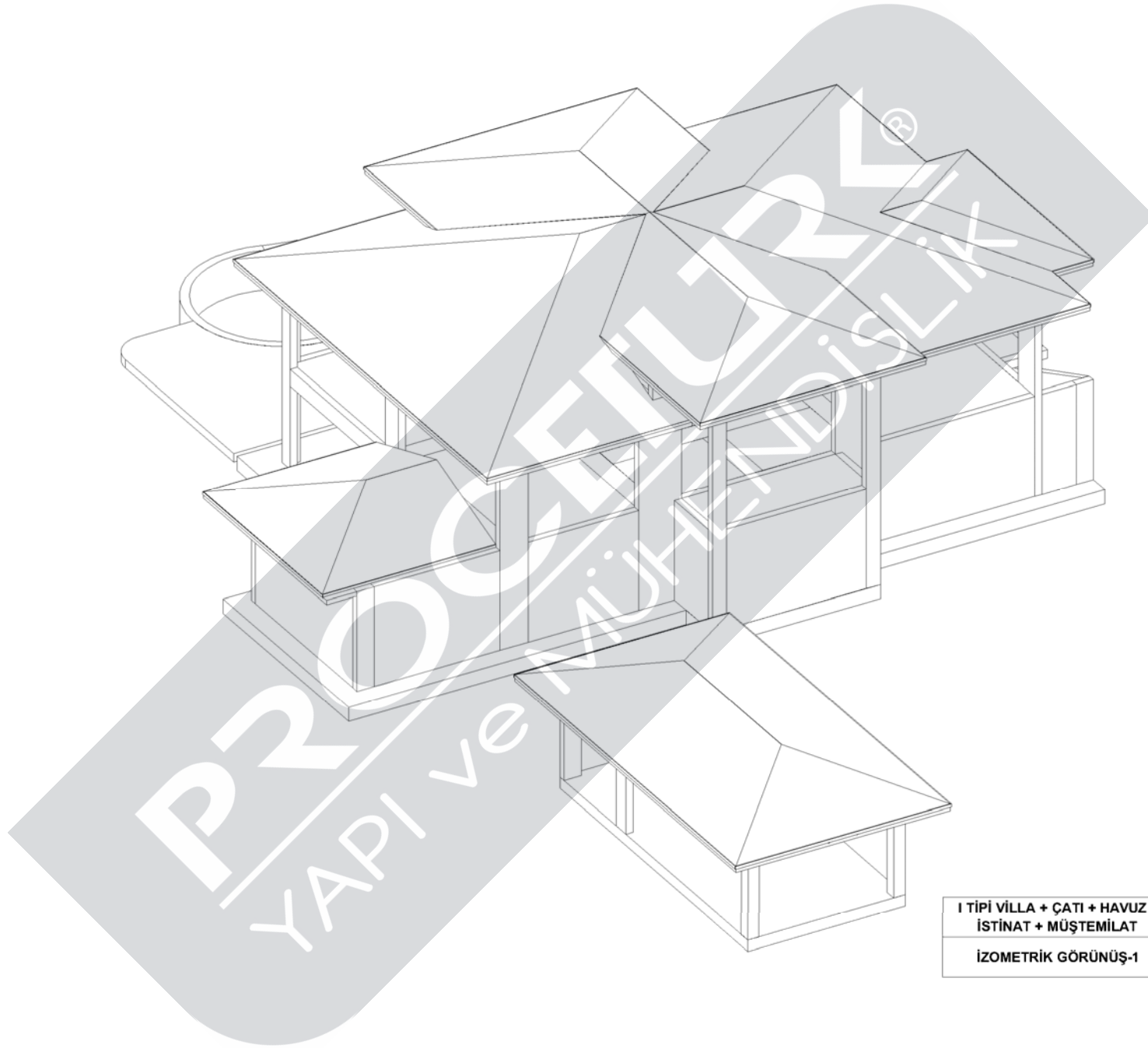

Konut ve Toplu Konutlar

Housing and Public Housing



I TİPİ VİLLA + ÇATI + HAVUZ +
İSTİNAT + MÜŞTEMİLAT
İZOMETRİK GÖRÜNÜŞ-1

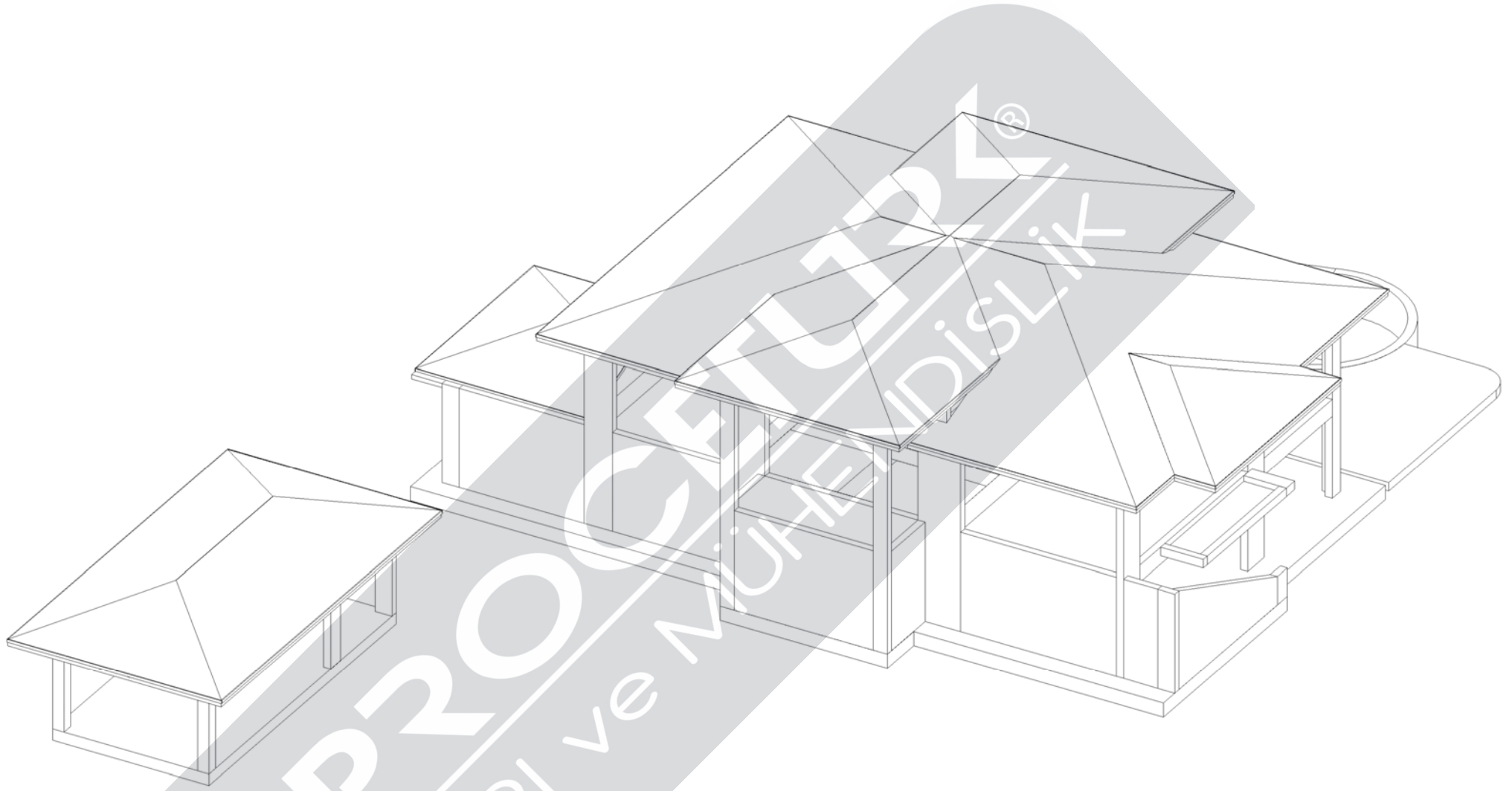

I TİPİ VİLLA + ÇATI + HAVUZ +
İSTİNAT + MÜŞTEMİLAT

İZOMETRİK GÖRÜNÜŞ-2

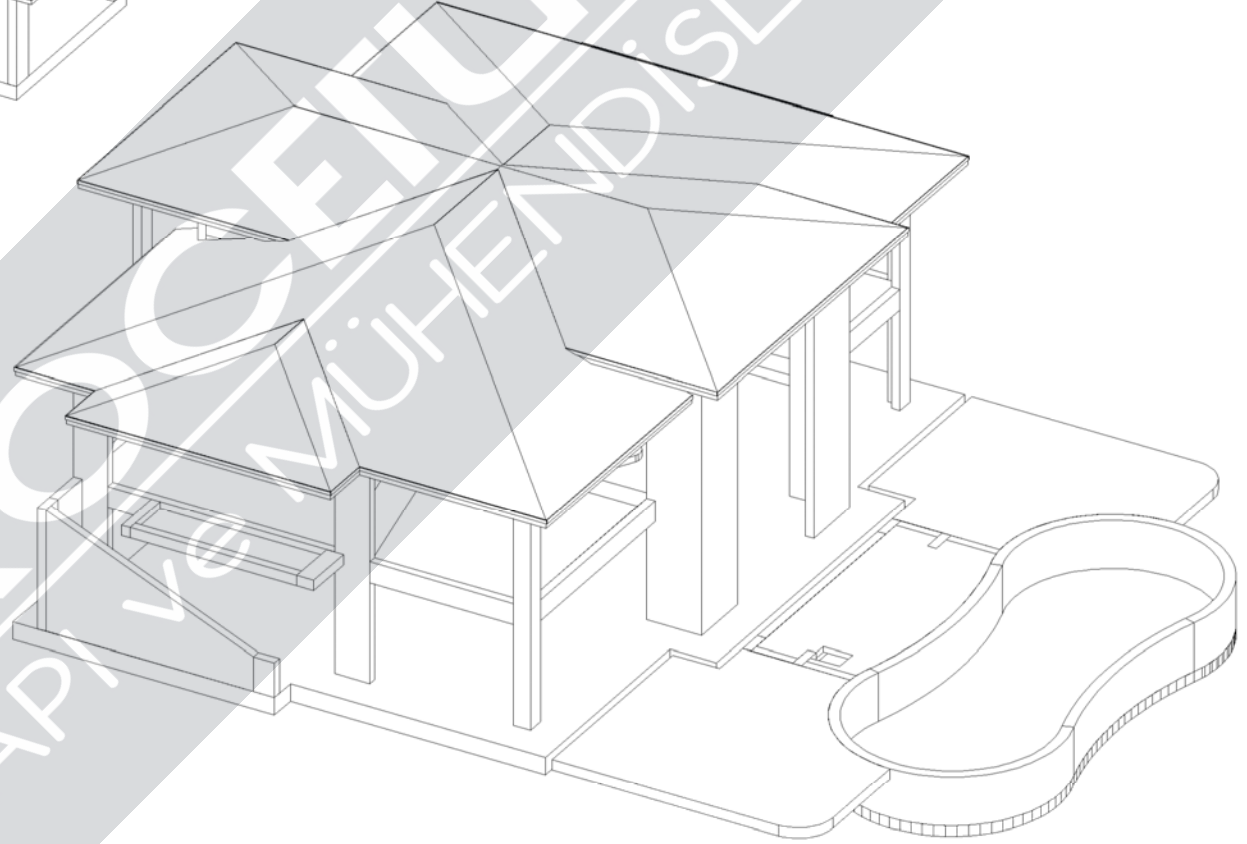
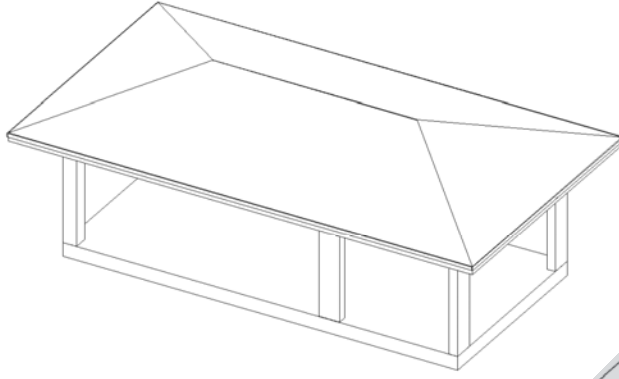

I TIPI VILLA + ÇATI + HAVUZ +
İSTINAT + MÜŞTEMLAT
İZOMETRİK GÖRÜNÜŞ-3

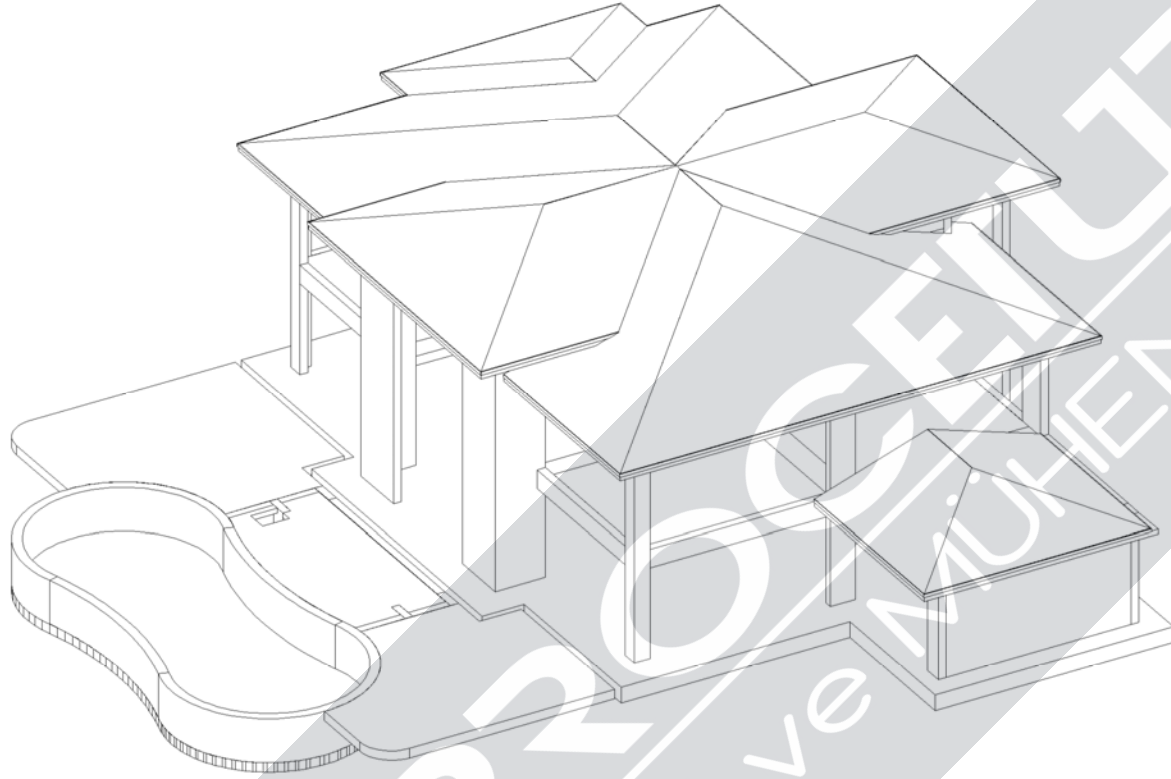

I TİPİ VİLLA + ÇATI + HAVUZ +
İSTİNAT + MÜŞTEMLAT
İZOMETRİK GÖRÜNÜŞ-4

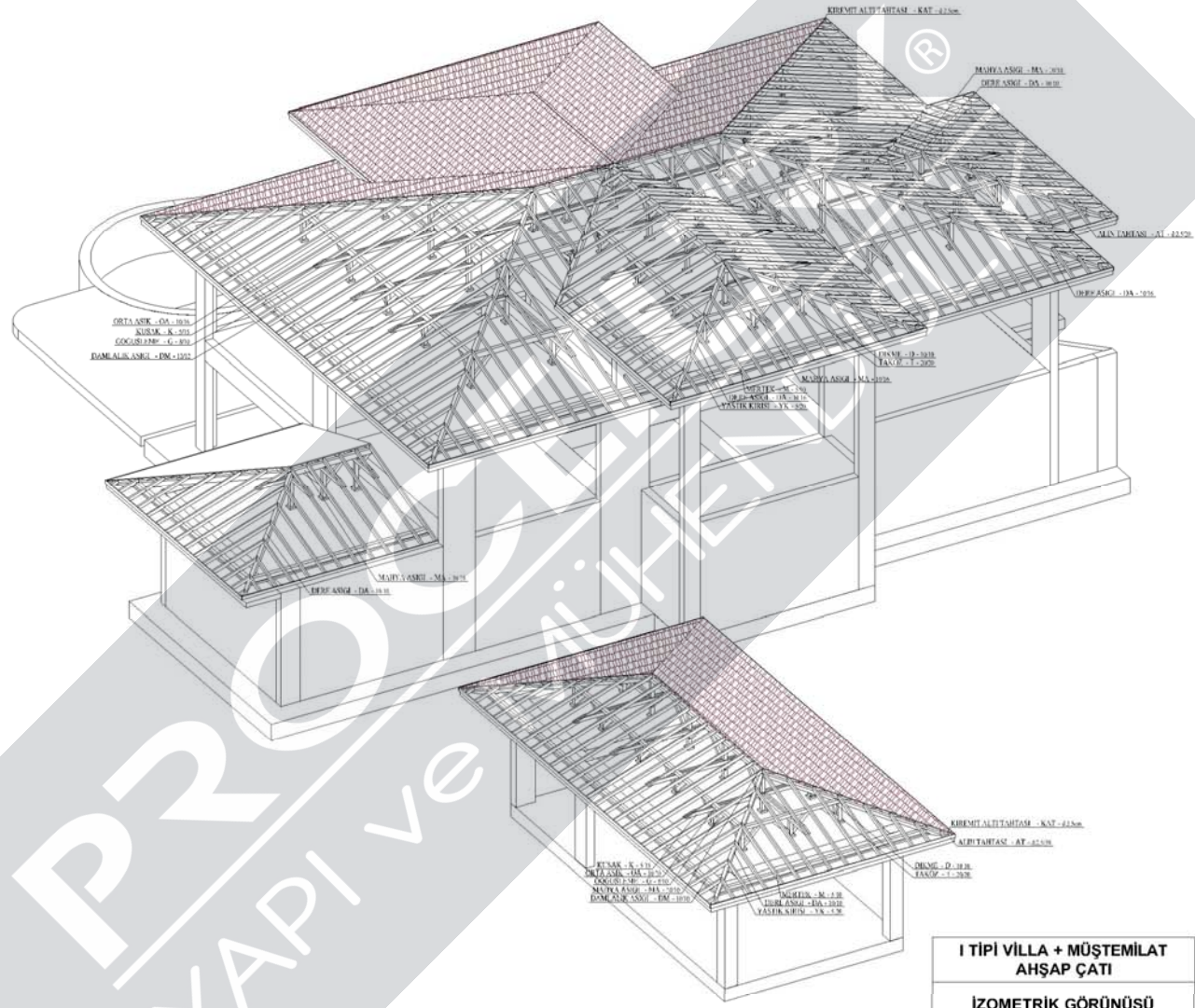

I TIPI VILLA + MÜSTEMİLAT
AHŞAP ÇATI
İZOMETRİK GÖRÜNÜŞÜ

ORTA ANK. - DA - 10/0
 KURUM. - K - 10/0
 GÖZLEMEY. - G - 10/0
 DİMLER/ASRİ - DM - 10/0

MURTA ASRİ - MA - 10/0
 DEĞİŞİM - DA - 10/0

KESAK - K - 10/0
 MURTA ASRİ - MA - 10/0
 GÖZLEMEY. - G - 10/0
 MURTA ASRİ - MA - 10/0
 DİM/ASRİ/ASRİ - DM - 10/0

MURTA ASRİ - MA - 10/0
 DEĞİŞİM - DA - 10/0
 KANAL - K - 10/0

KİBİMLİ ALTITAMAM - KAT - 10/0

MURTA ASRİ - MA - 10/0
 DEĞİŞİM - DA - 10/0

MURTA ASRİ - MA - 10/0

MURTA ASRİ - MA - 10/0

DEĞİŞİM - DA - 10/0
 KANAL - K - 10/0

KİBİMLİ ALTITAMAM - KAT - 10/0
 MURTA ASRİ - MA - 10/0

DEĞİŞİM - DA - 10/0
 KANAL - K - 10/0

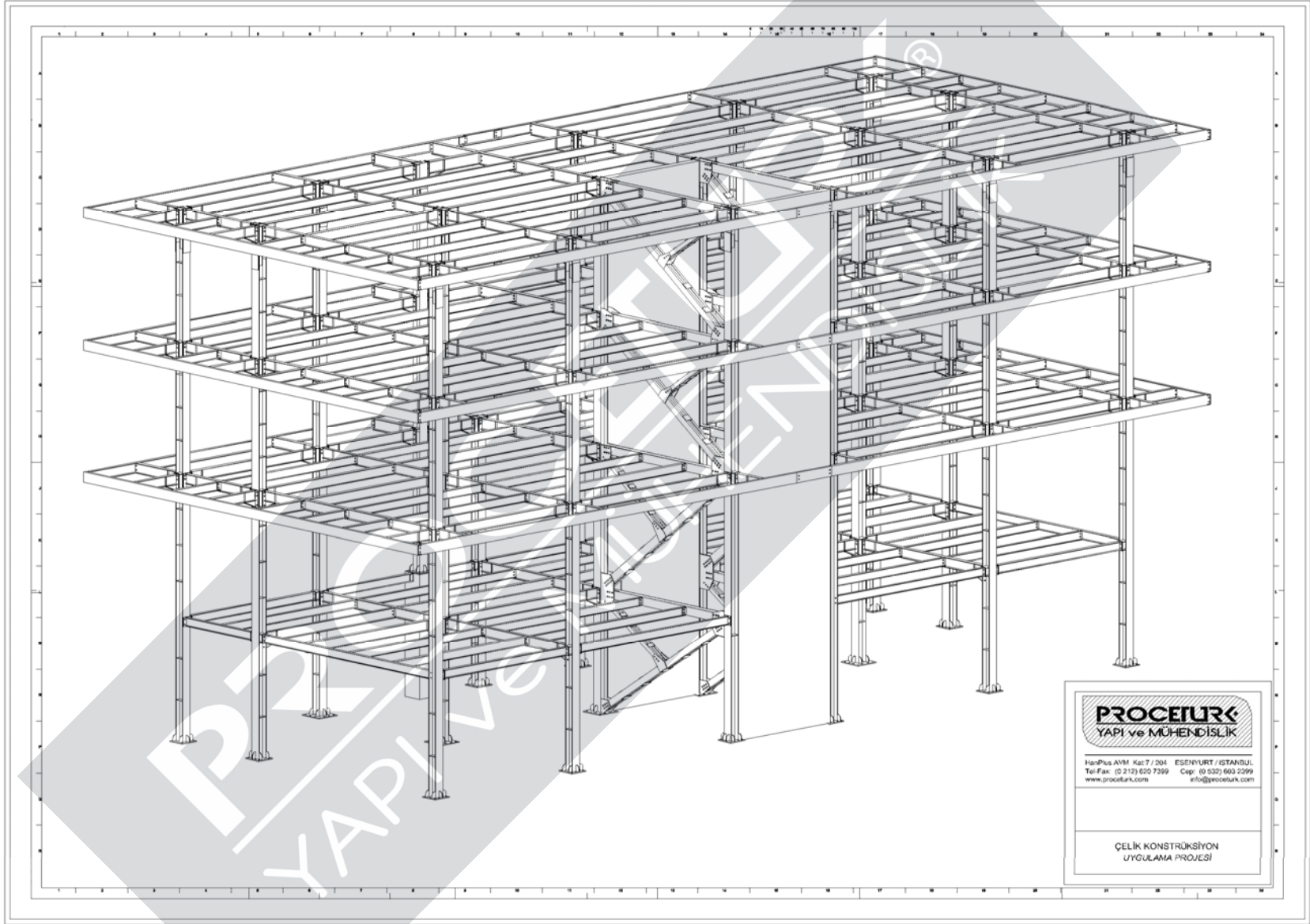

PROCELURK
YAPI ve MÜHÜR

HanPlus AVM Kat:7 / 204 ESENÜRT / İSTANBUL
Tel-Fax: (0 212) 620 7399 Cep: (0 532) 603 2399
www.procelurk.com info@procelurk.com

ÇELİK KONSTRÜKSİYON
UYGULAMA PROJESİ



PROJETUR
YAPI ve MÜHENDİSLİK

MerPlus AVM Kat 7 / 204 ESENYURT / İSTANBUL
Tel-Fax: (0 212) 620 7399 Cep: (0 532) 603 2399
www.projetur.com info@projetur.com

ÇELİK ÇATISI
UYGULAMA PROJESİ

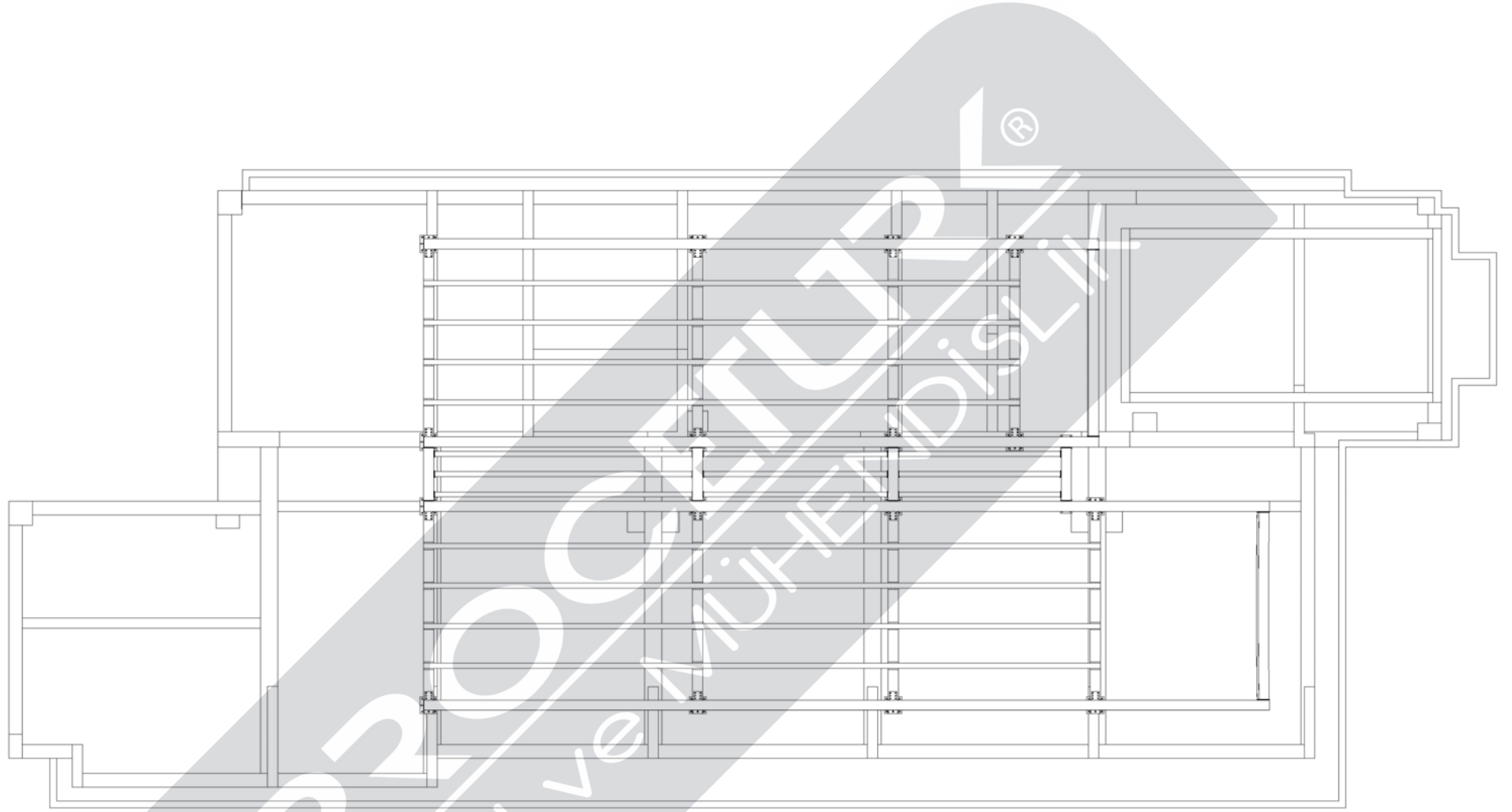

ÜSTEN GÖRÜNÜS 1
1:100

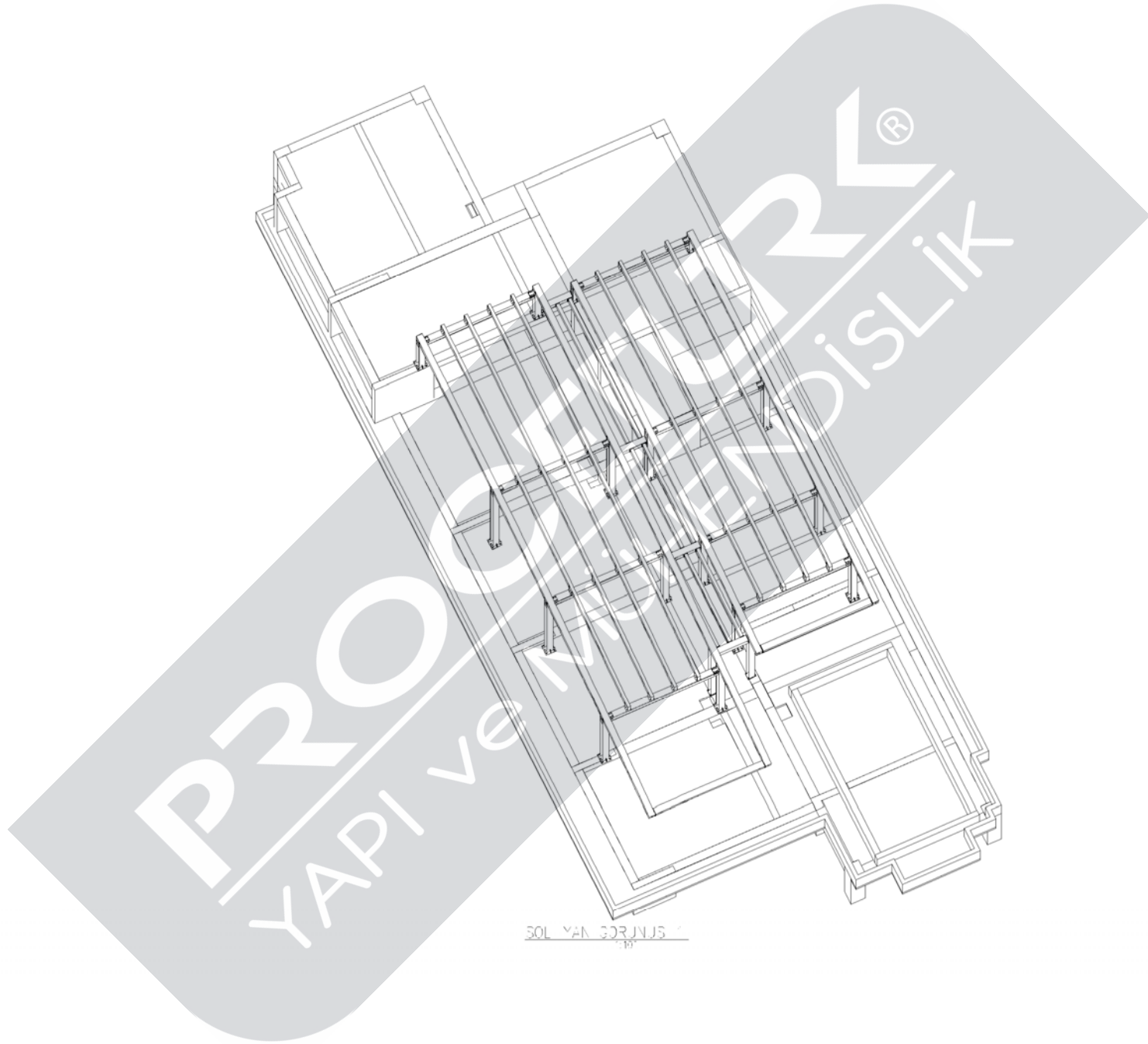

SOL YAN SÜRÜNGÜSÜ

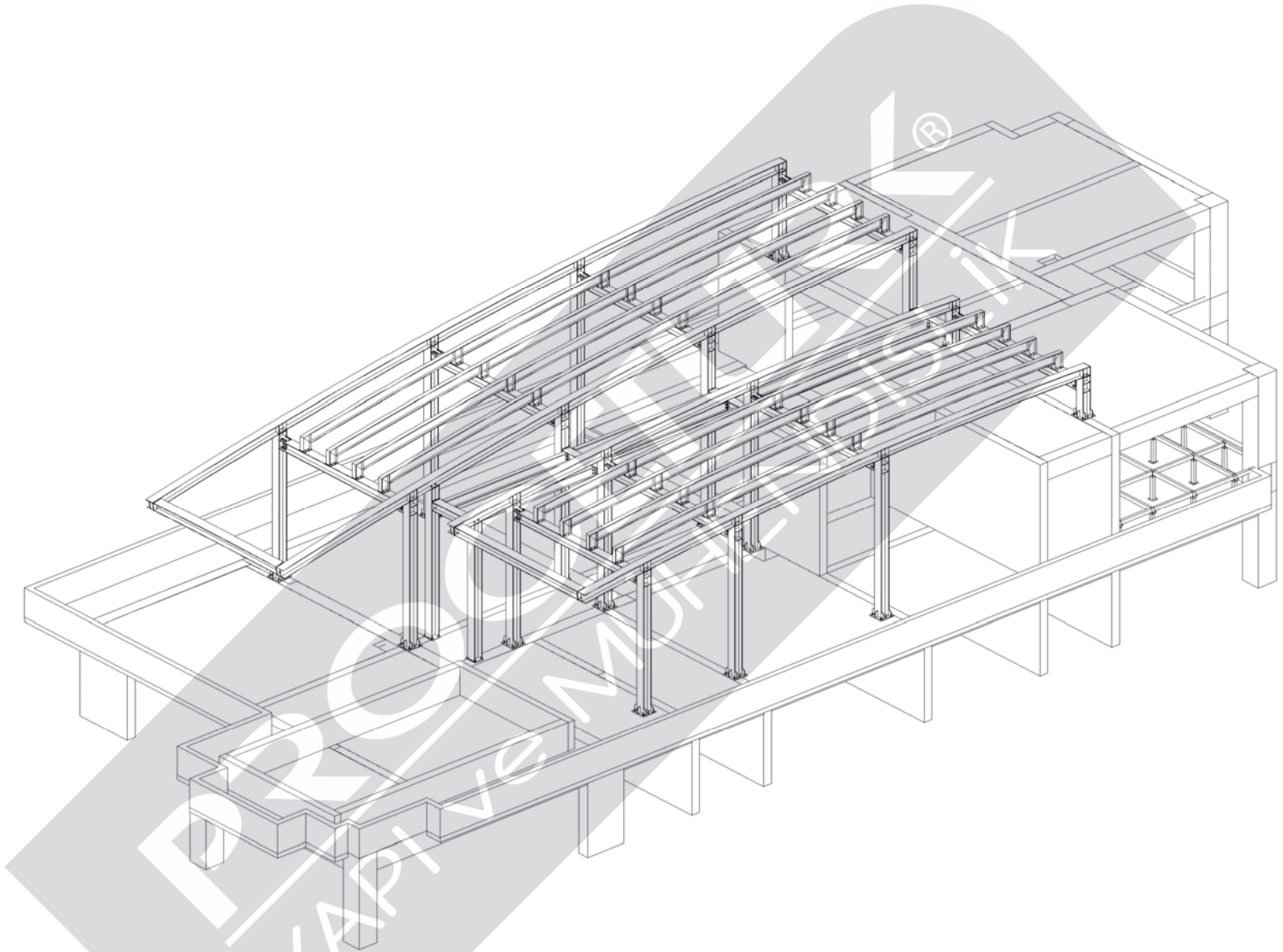

SAG-YAN GORUNUS-1
1/10

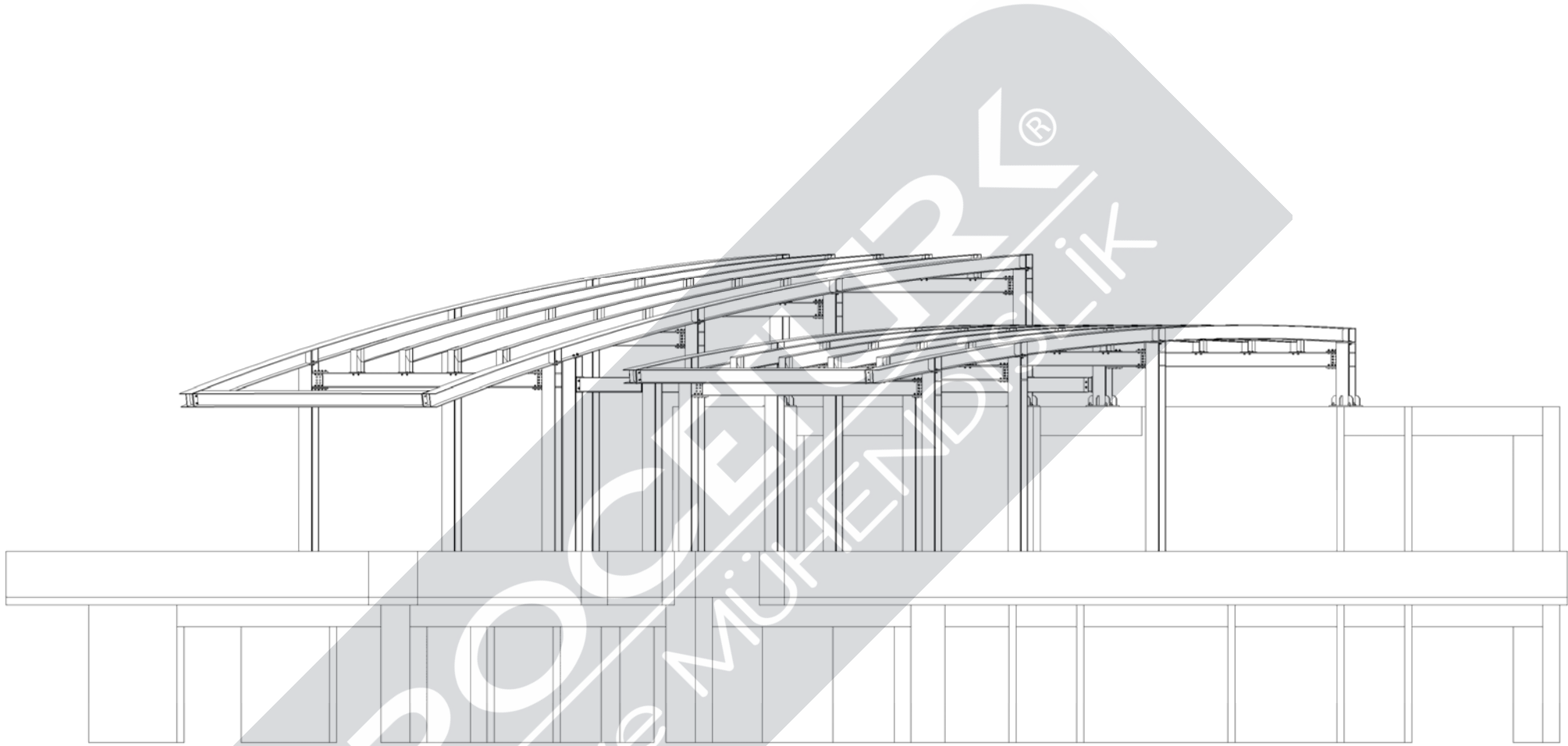

SAG-YAN GORUNUS-2

1:100





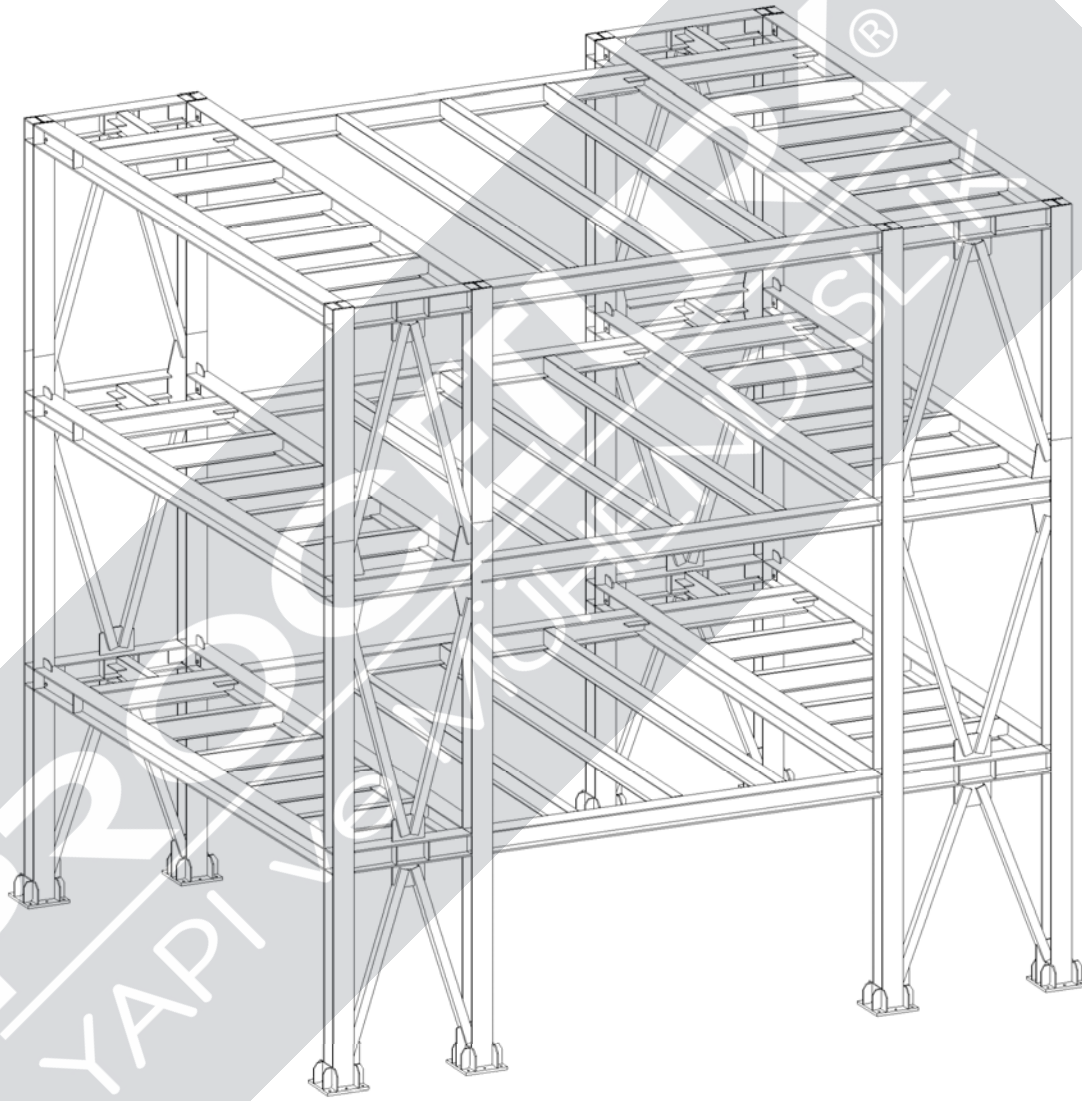

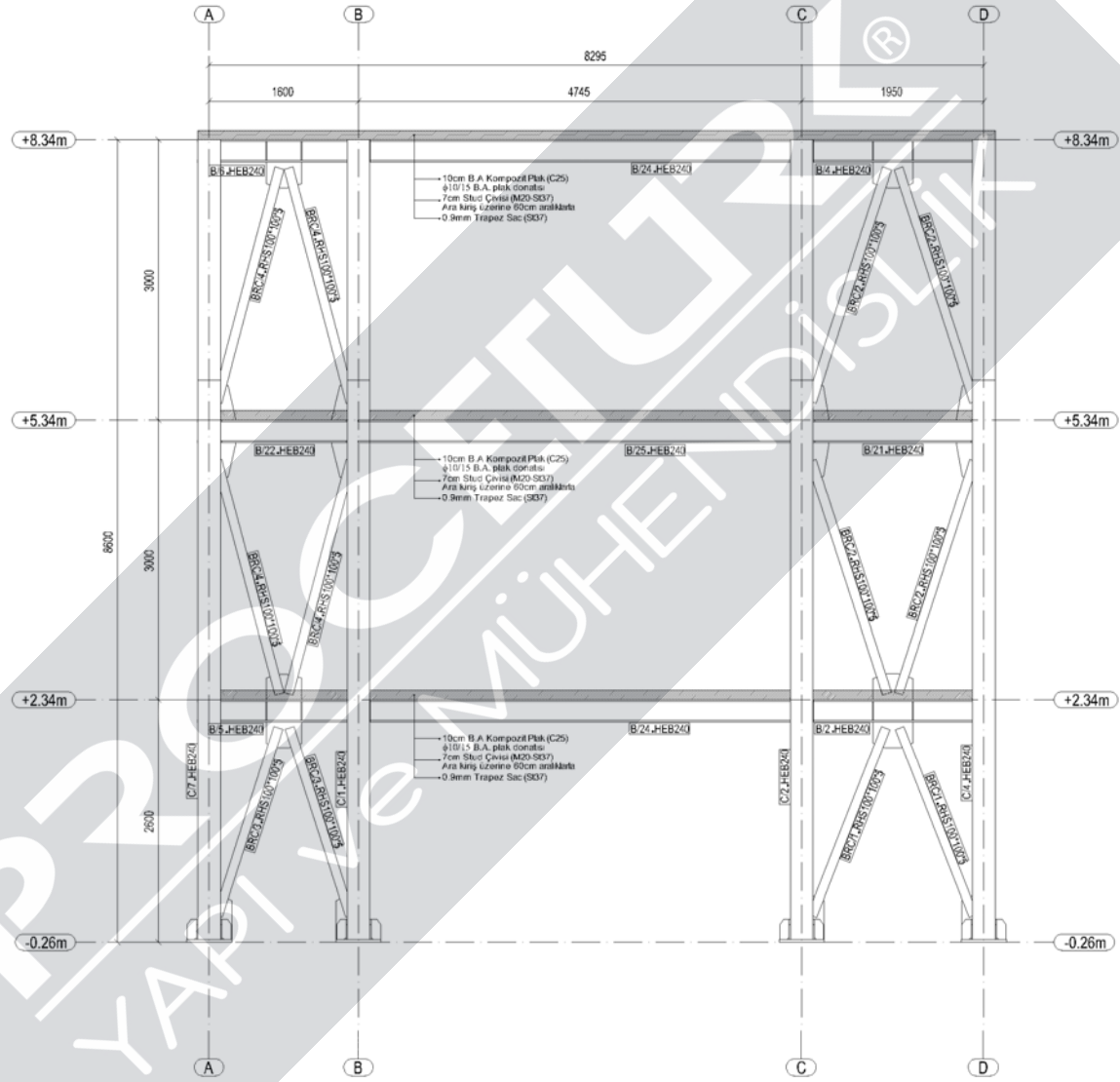

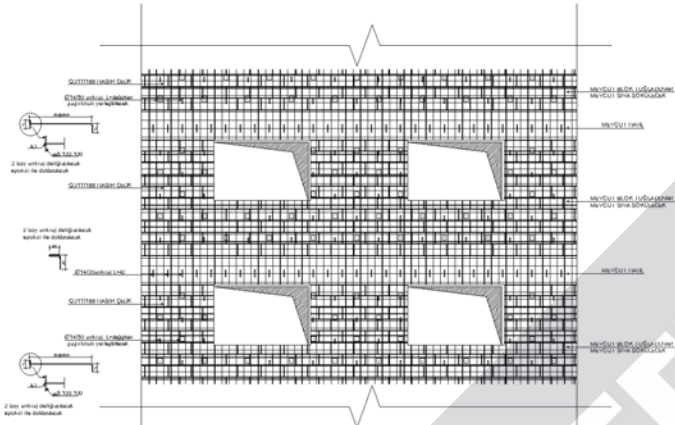

TIPIK ÖN CEPHE DUVAR DETAYI

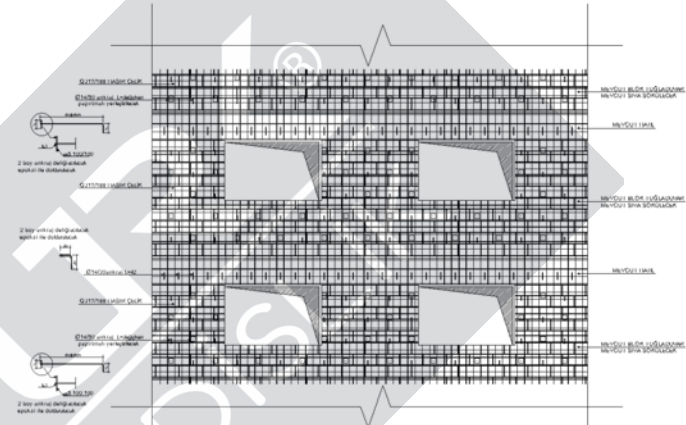

TIPIK İÇ DUVAR DETAYI

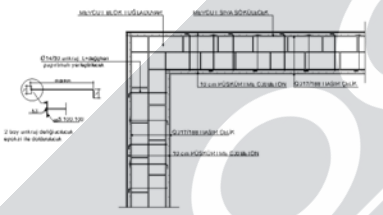

TIPIK KÖŞE DUVAR DETAYI

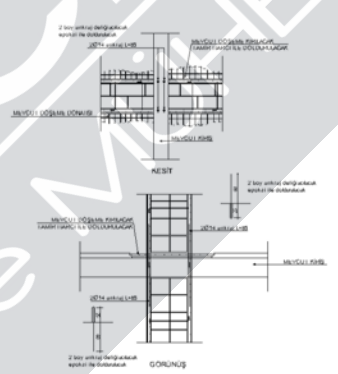

TIPIK DUVAR-KIRIŞ BİRLEŞİM DETAYI

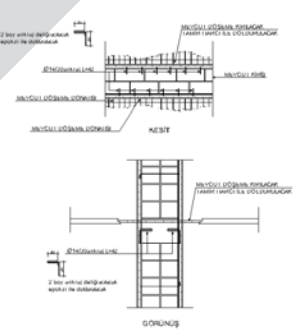

TIPIK DUVAR-KIRIŞ BİRLEŞİM DETAYI

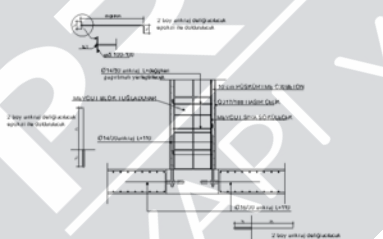

TIPIK TEMEL DETAYI

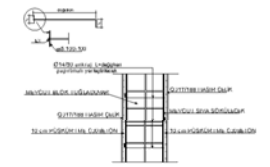

TIPIK DUVAR DETAYI

