

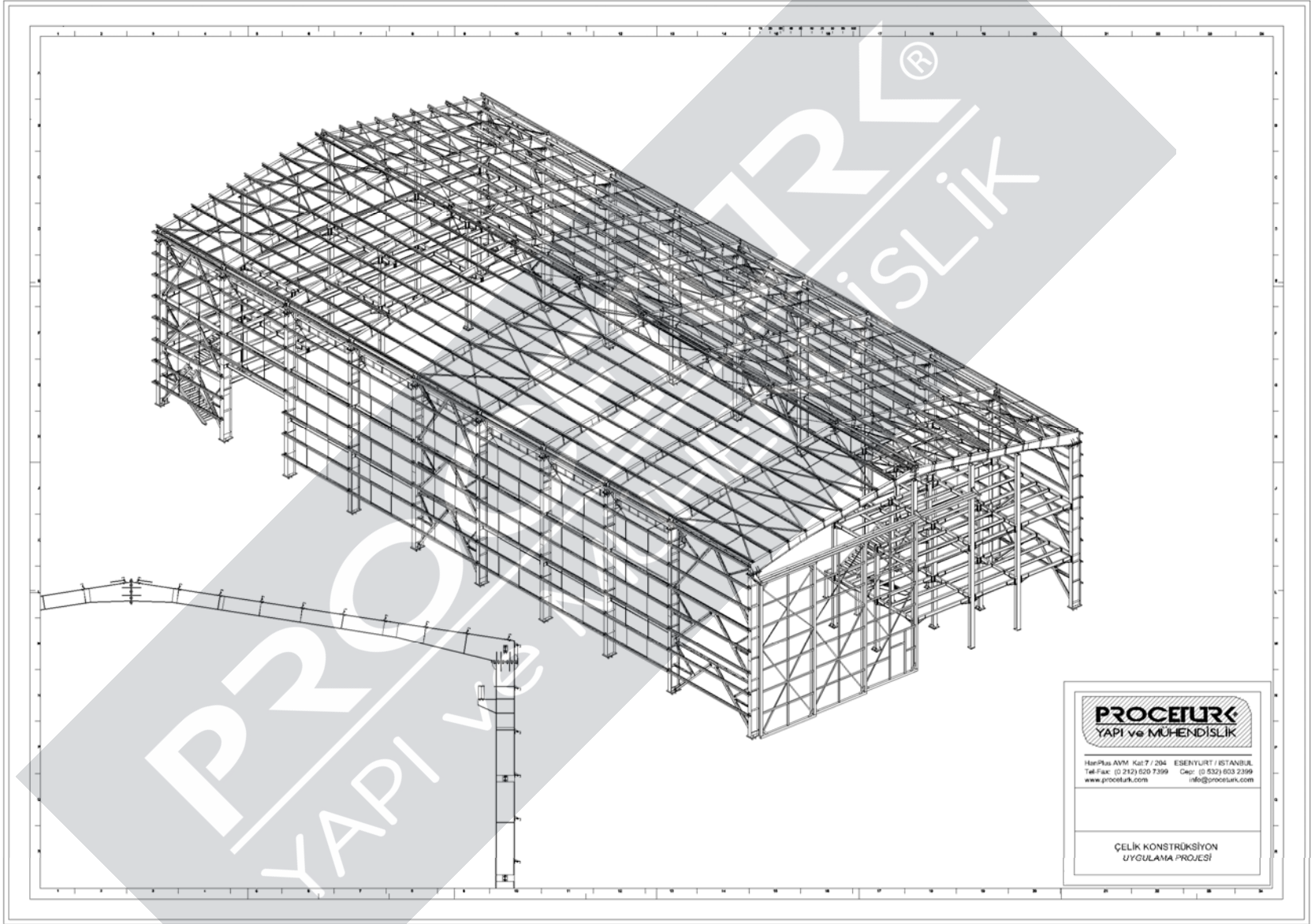

Endüstriyel-Sanayi Yapıları

Industrial Buildings



PROCELURK
YAPI ve MÜHENDİSLİK

Haritası AVM Kat: 7 / 204 ESENLYURT / İSTANBUL
Tel-Fax: (0 212) 620 7399 Cep: (0 532) 603 2399
www.procelurk.com info@procelurk.com

ÇELİK KONSTRÜKSİYON
UYGULAMA PROJESİ

PROCEURK
YAPI ve MÜHENDİSLİK

HanPlaza AVM Kat:7 / 204 ESENYURT / İSTANBUL
Tel: Fax: (0 212) 620 7399 Cep: (0 532) 603 2399
www.proceurk.com info@proceurk.com

ÇELİK KONSTRÜKSİYON
UYGULAMA PROJESİ

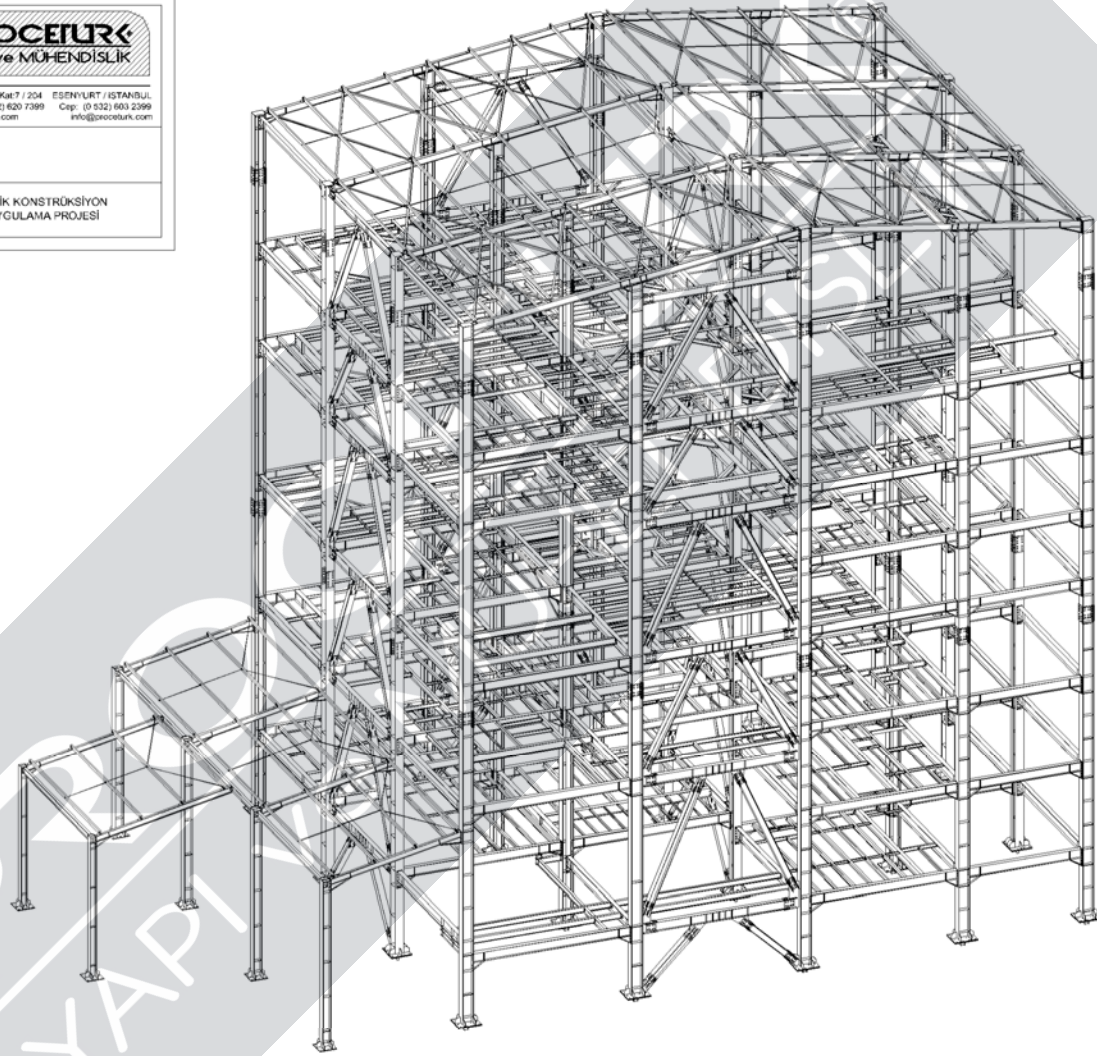

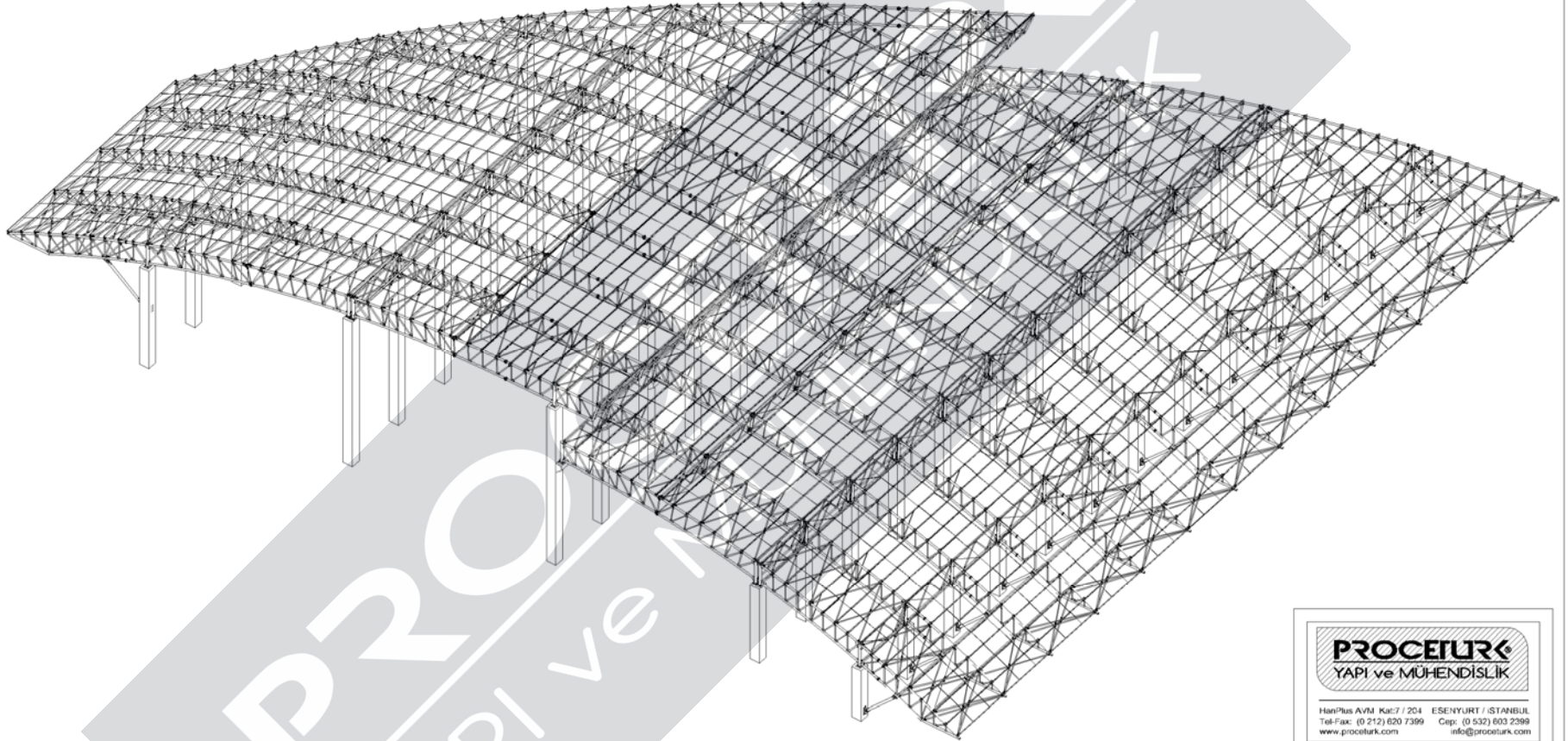

PROCEURK
YAPI ve MÜHENDİSLİK

HanPlus AVM Kat:7 / 204 ESENYURT / İSTANBUL
Tel-Fax: (0 212) 620 7399 Cep: (0 532) 603 2399
www.proceurk.com info@proceurk.com

ÇELİK ÇATISI (6 500 m²)
UYGULAMA PROJESİ

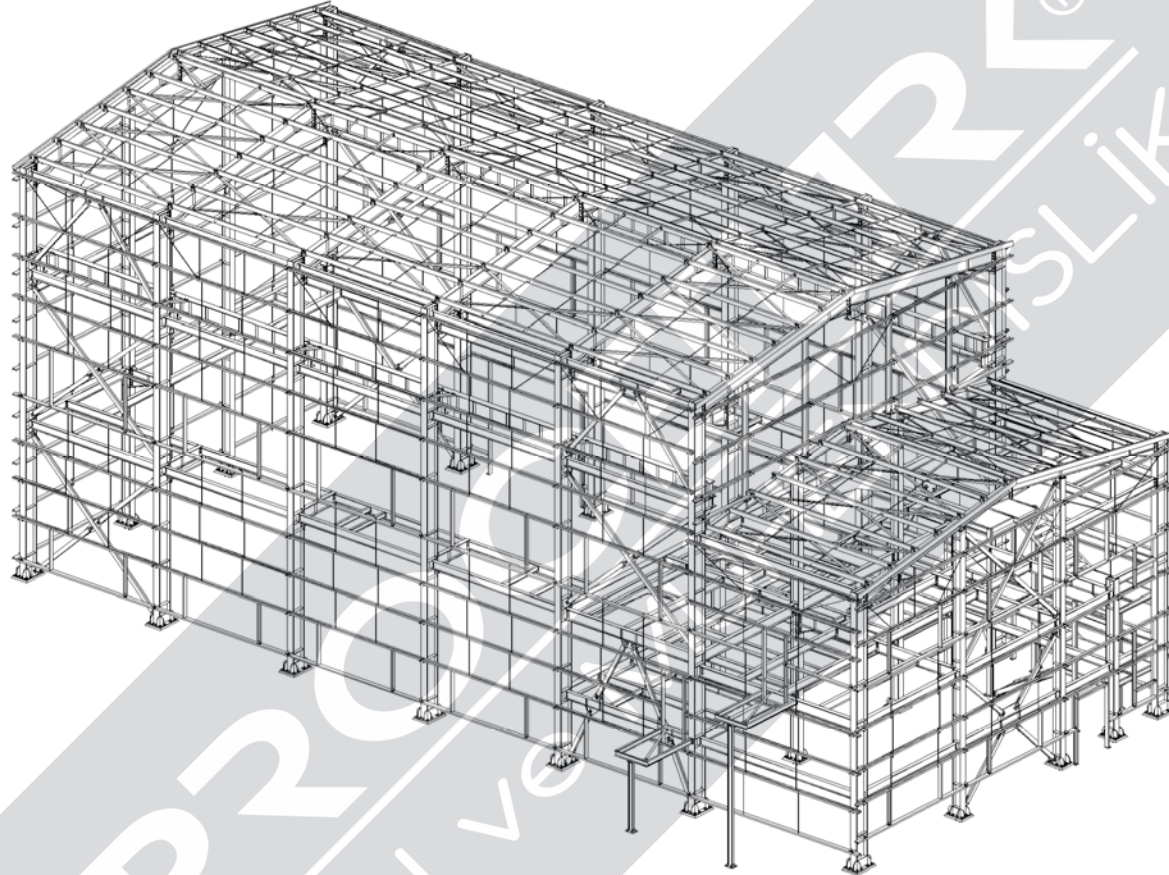

PROJETUR
YAPI ve MÜHENDİSLİK

HanPlas AVM Kat:7 / 204 ESENÜRT / İSTANBUL
Tel-Fax: (0 212) 620 7399 Cep: (0 532) 603 2399
www.projetur.com info@projetur.com

ÇELİK KONSTRÜKSİYON
PROJESİ



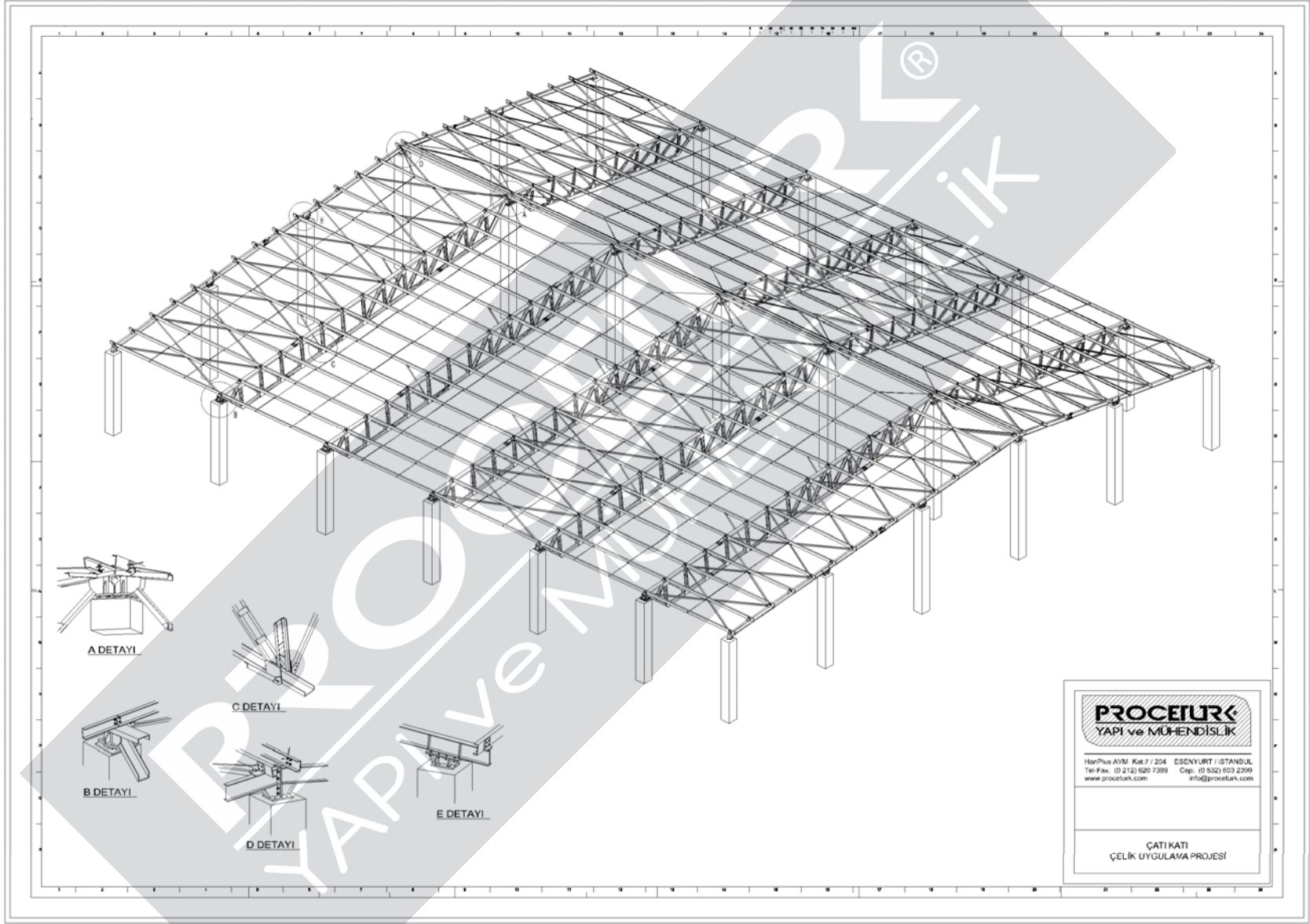

A DETAYI

B DETAYI

C DETAYI

D DETAYI

E DETAYI

PROCELTURK
YAPI ve MÜHENDİSLİK

HürPis AVM Kat:7 / 204 EBENÜRT / İSTANBUL
Tel:Fax: (0 212) 620 7399 Çep: (0 212) 623 2399
www.procelturk.com info@procelturk.com

ÇATI KATI
ÇELİK UYGULAMA PROJESİ

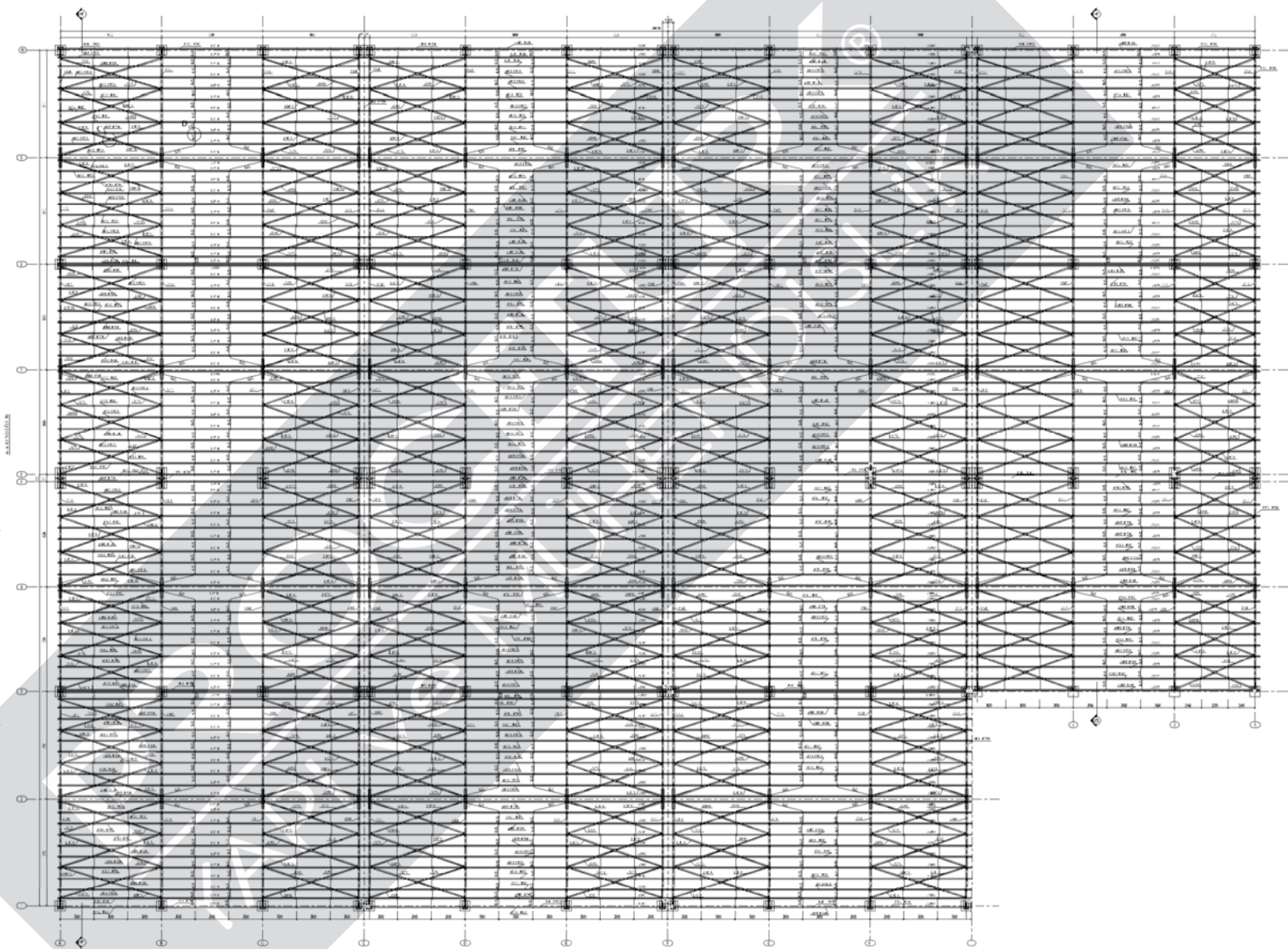
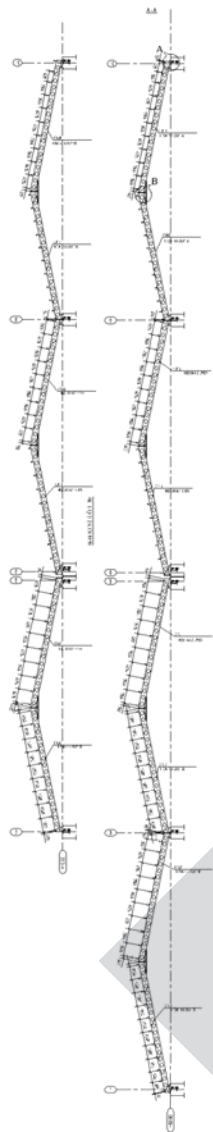

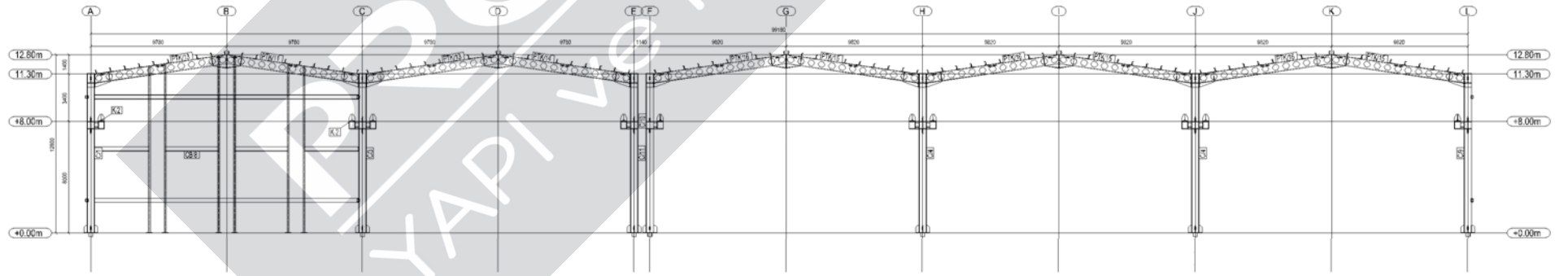
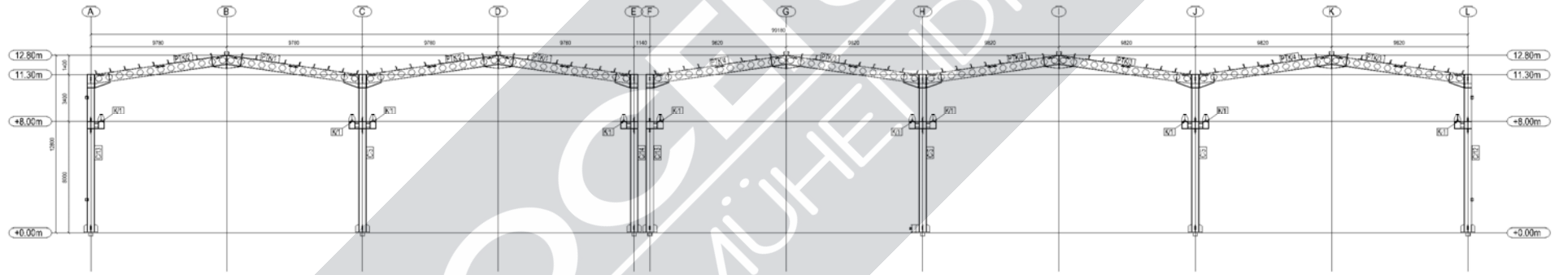
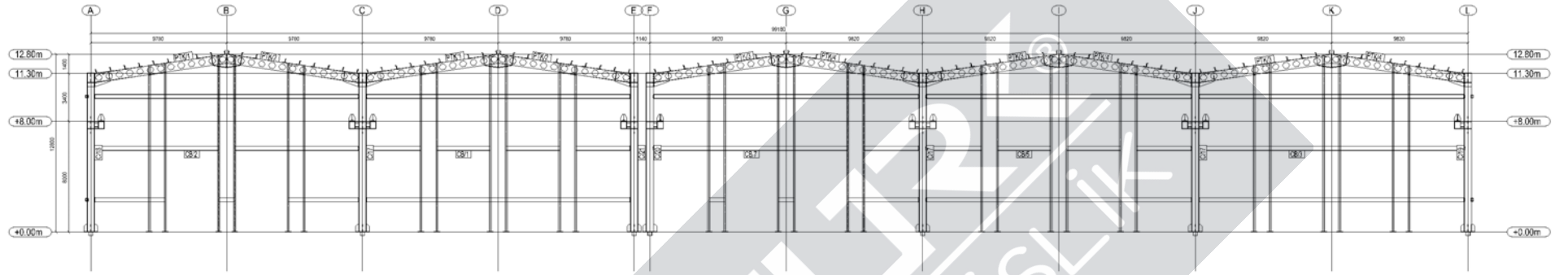

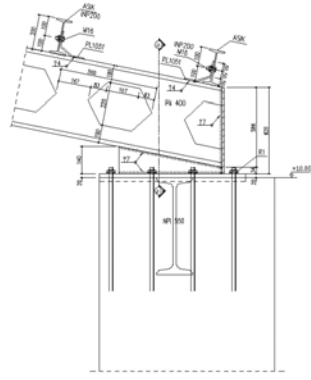

A DETAYI 0:1/10

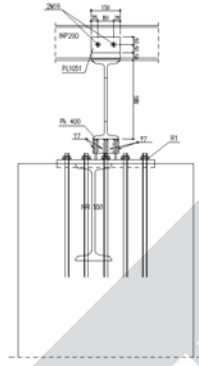

a1-a1 KESİTİ 0:1/10



B DETAYI 0:1/10

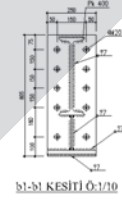

b1-b1 KESİTİ 0:1/10

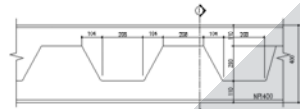

PK580 KİRİŞİ ÜRETİM DETAYI 0:1/10

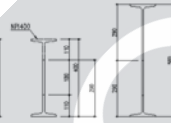

K1-K1 KESİTİ 0:1/10



KA-KAK DETAYI



C DETAYI 0:1/10

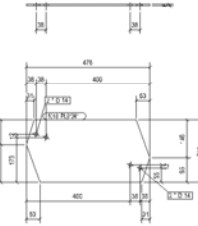

KENAR ÇATI ÇAPRAZ PLAKASI



A-A KESİTİ 0:1/10

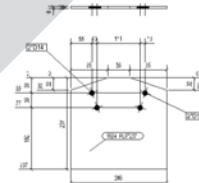

ORTA ÇATI ÇAPRAZ PLAKASI

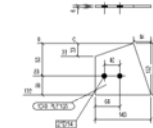

KENAR ÇATI ÇAPRAZ PLAKASI



NP180 EK DETAYI

a1-a1 KESİTİ



020 GERGİ ÇUBUĞU
DETAYI 0:1/10
G.Ç.

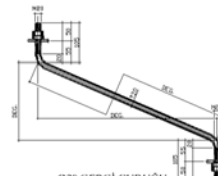

020 GERGİ ÇUBUĞU
DETAYI 0:1/10
G.Ç.

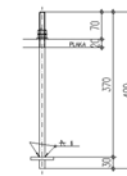

R1 M20 RODLAR İÇİN
1 ADET KOLON İÇİN 20 ADET

d1-d1 KESİTİ 0:1/10

D DETAYI 0:1/10

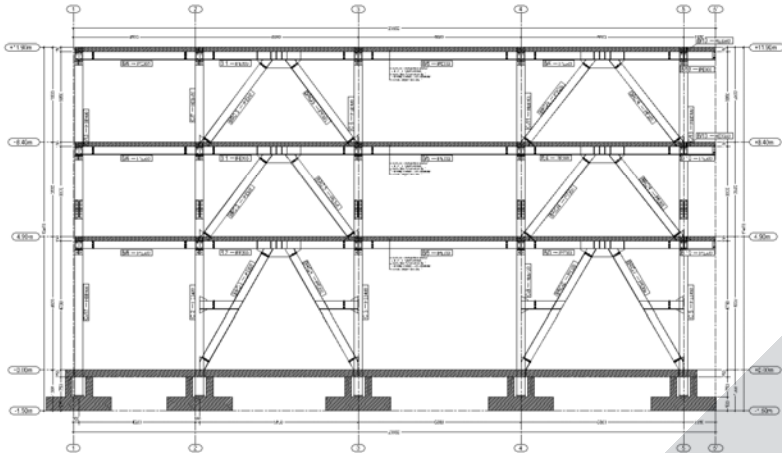

"A-A" ANI KEŞİT GÖRÜNÜŞÜ (1/50)

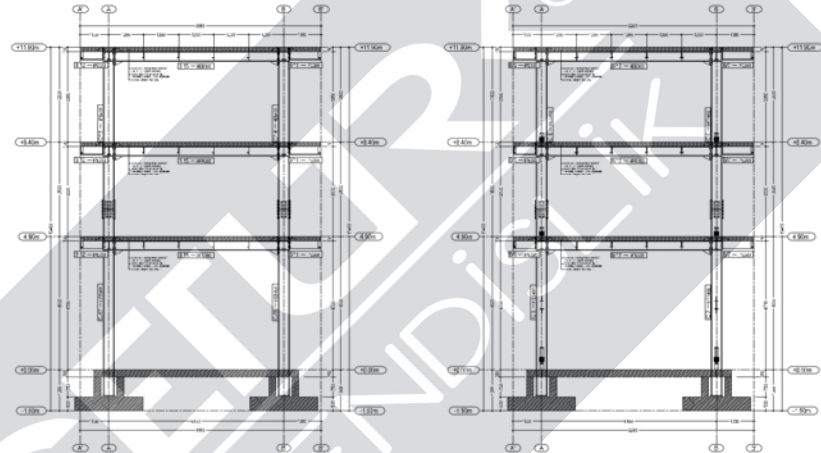

"1-1" ANI KEŞİT GÖRÜNÜŞÜ (1/50)

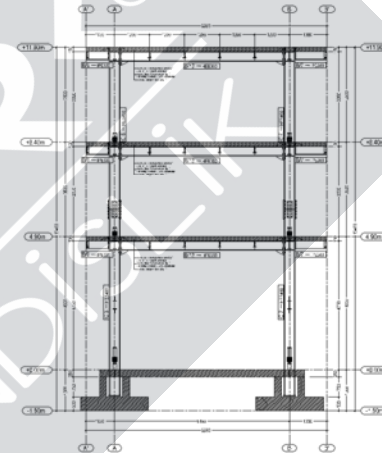

"3-3" ANI KEŞİT GÖRÜNÜŞÜ (1/50)

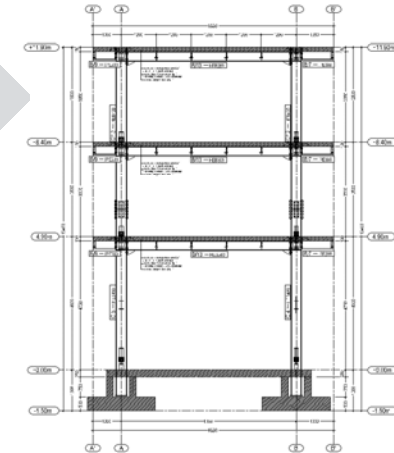

"5-5" ANI KEŞİT GÖRÜNÜŞÜ (1/50)

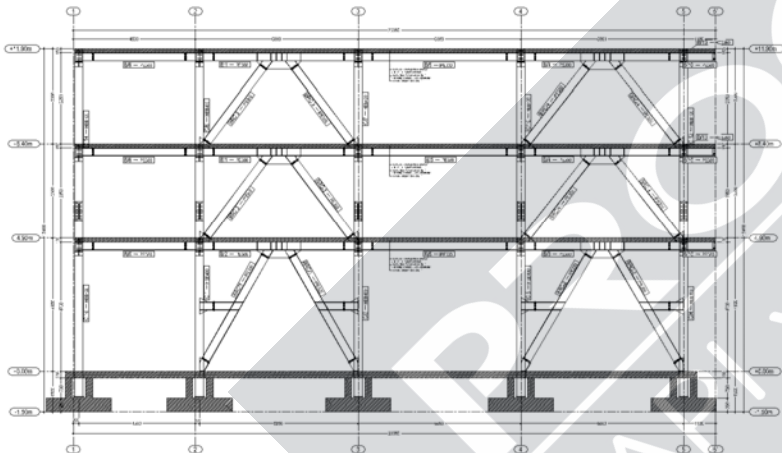

"8-8" ANI KEŞİT GÖRÜNÜŞÜ (1/50)

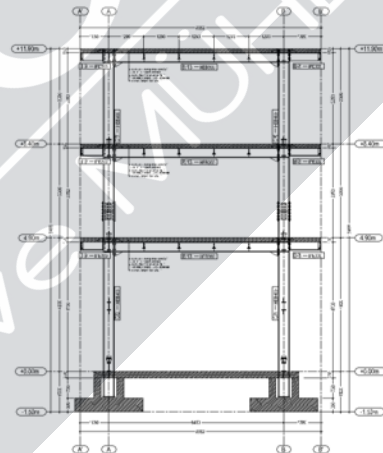

"4-4" ANI KEŞİT GÖRÜNÜŞÜ (1/50)

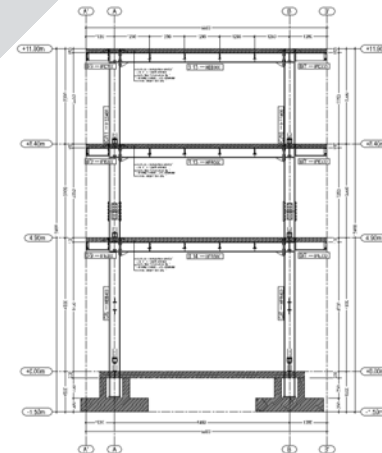

"2-2" ANI KEŞİT GÖRÜNÜŞÜ (1/50)

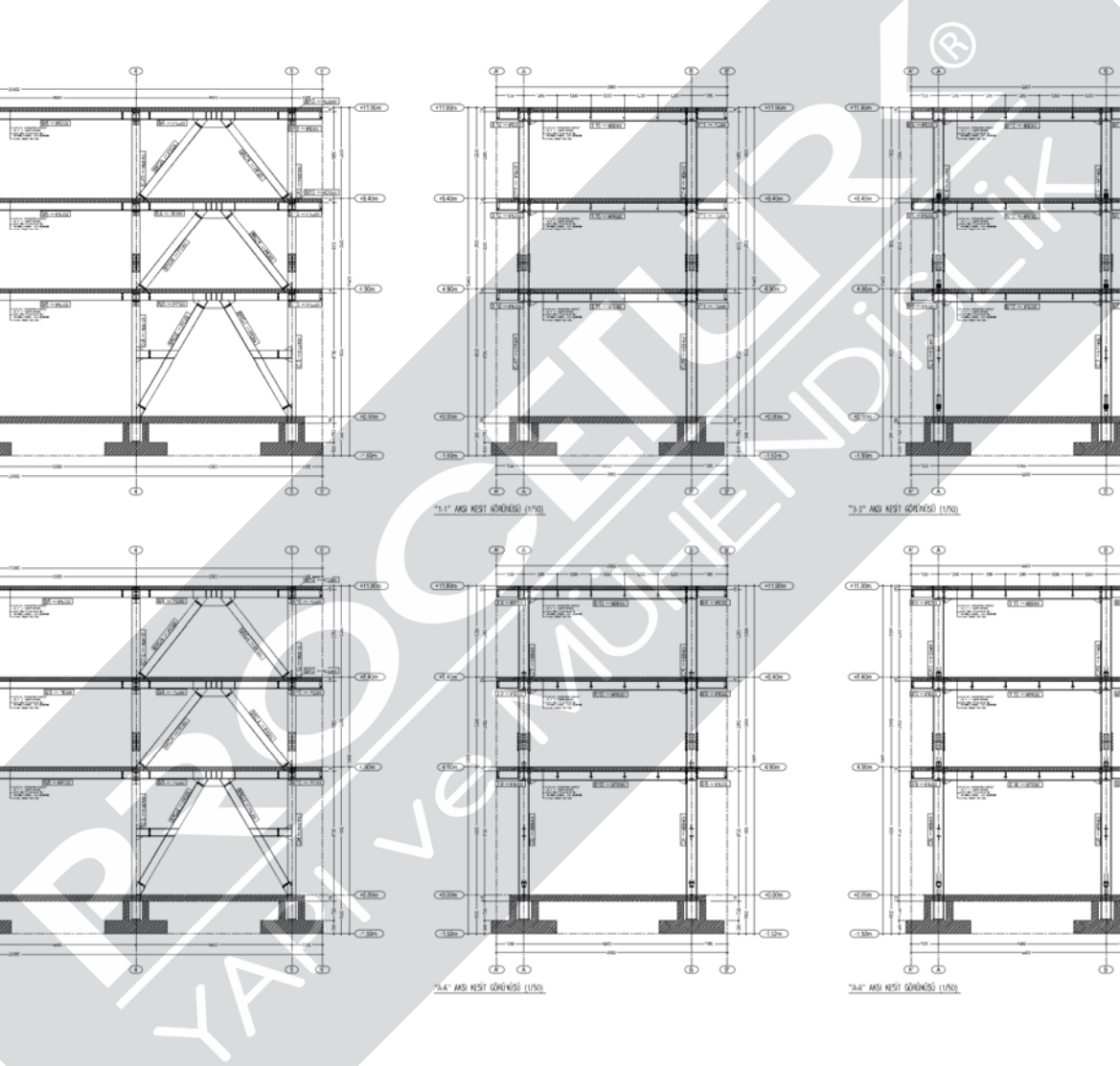

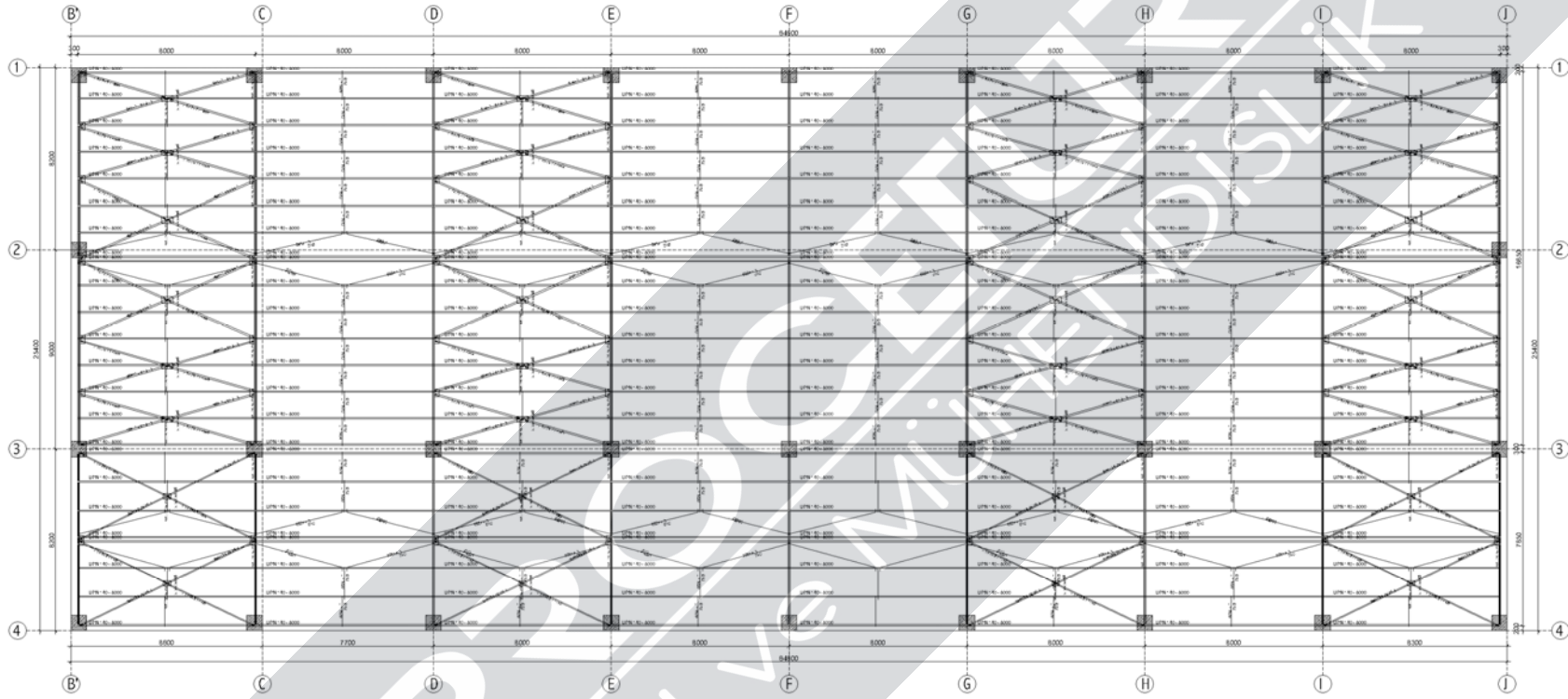

MAKAS YERLEŞİM PLANI ÖL:1/50

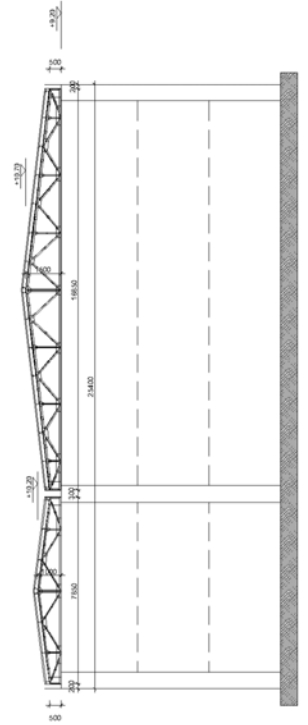

MAKAS KESİT GÖRÜNÜŞÜ ÖL:1/50

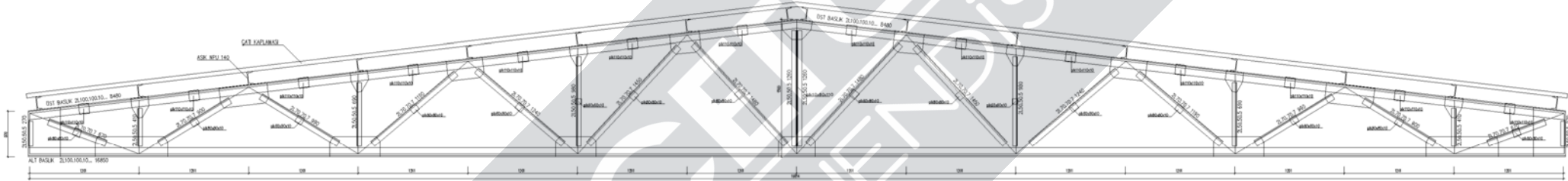
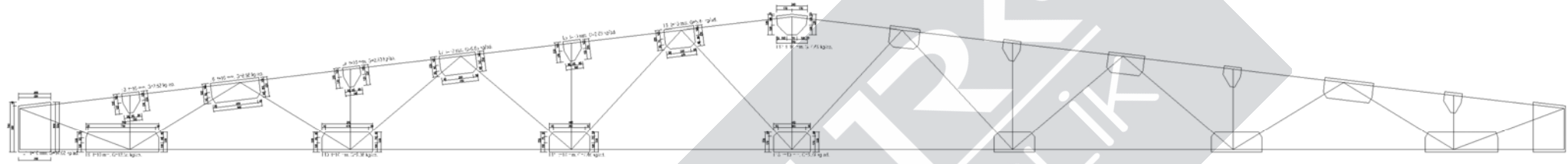

MAKAS TIP-1 (16.85 metre) Detay Öl:1/10

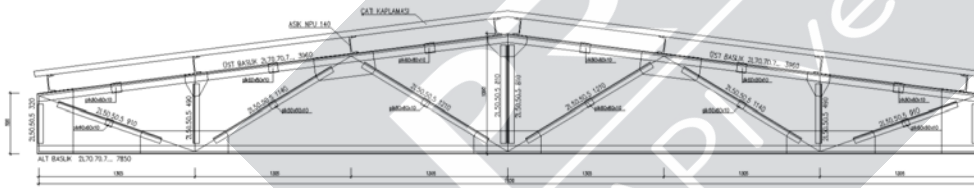
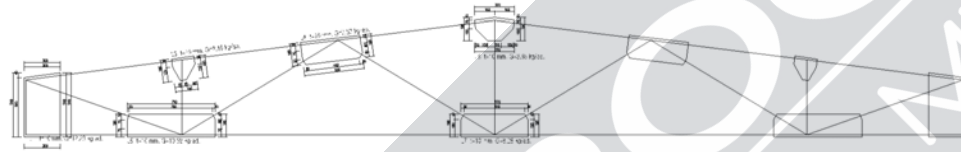

MAKAS TIP-1 (7.85 metre) Detay Öl:1/10

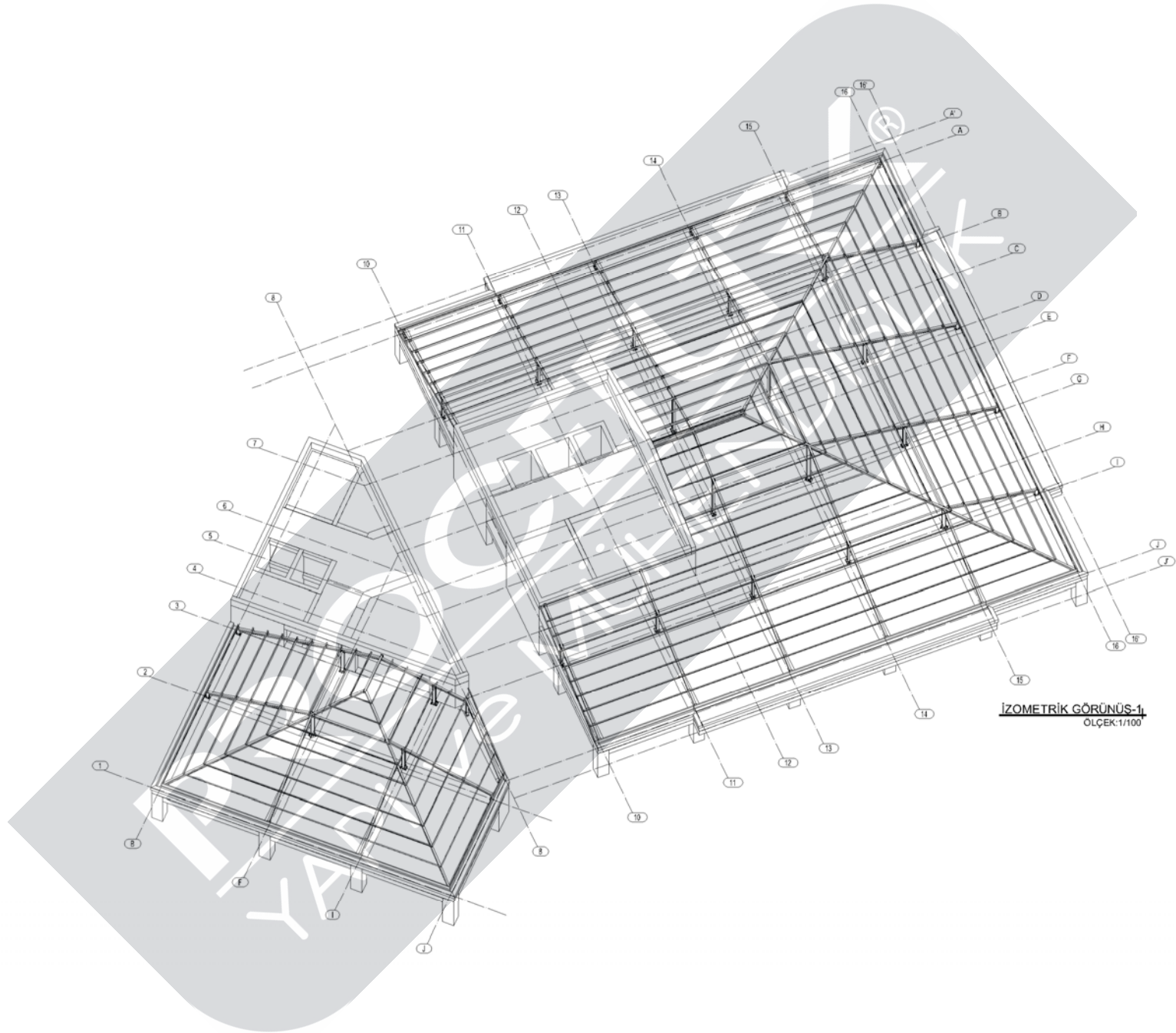

İZOMETRİK GÖRÜNÜŞ-1
ÖLÇEK:1/100

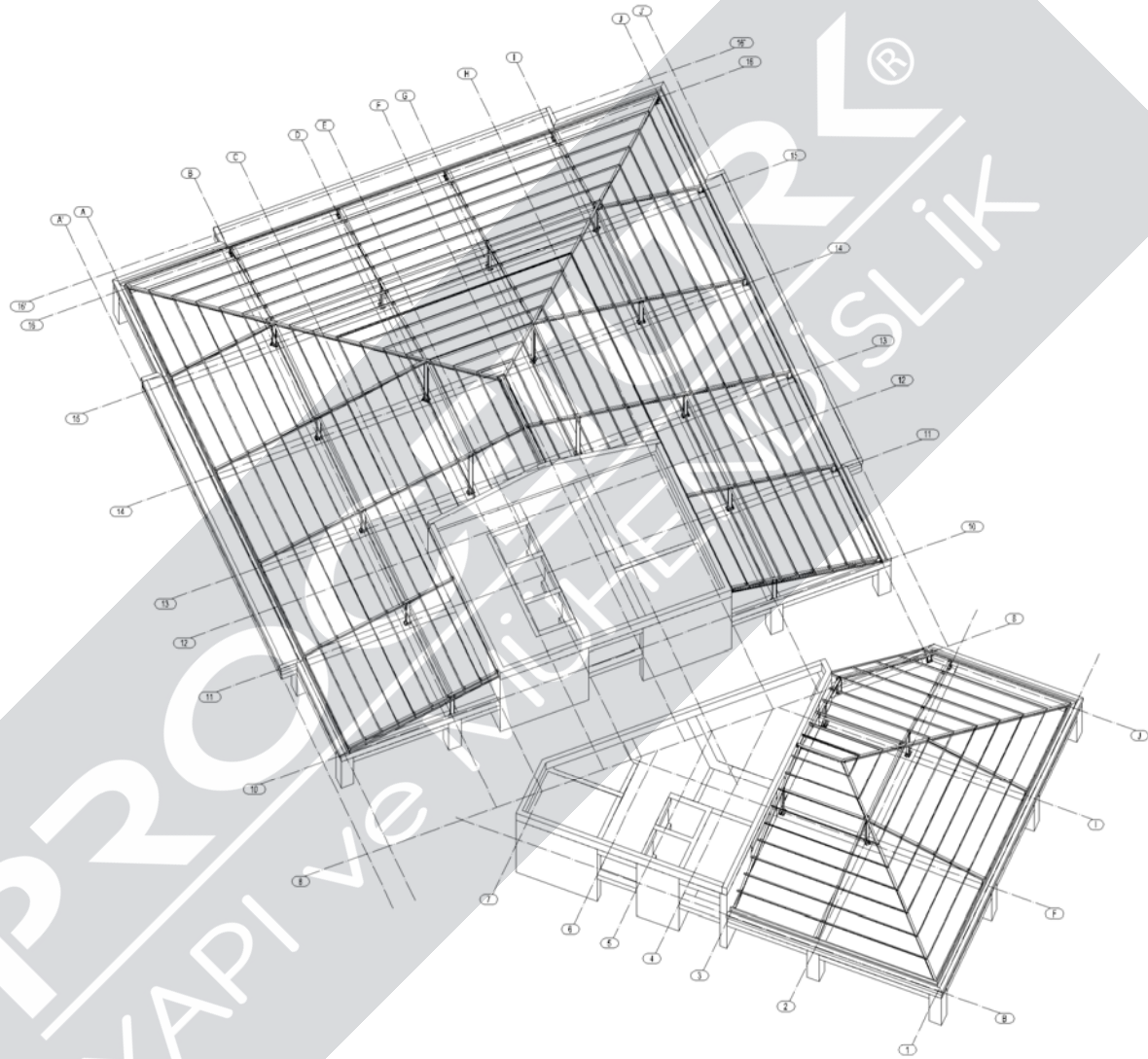

İZOMETRİK GÖRÜNÜŞ-2
ÖLÇEK: 1/100

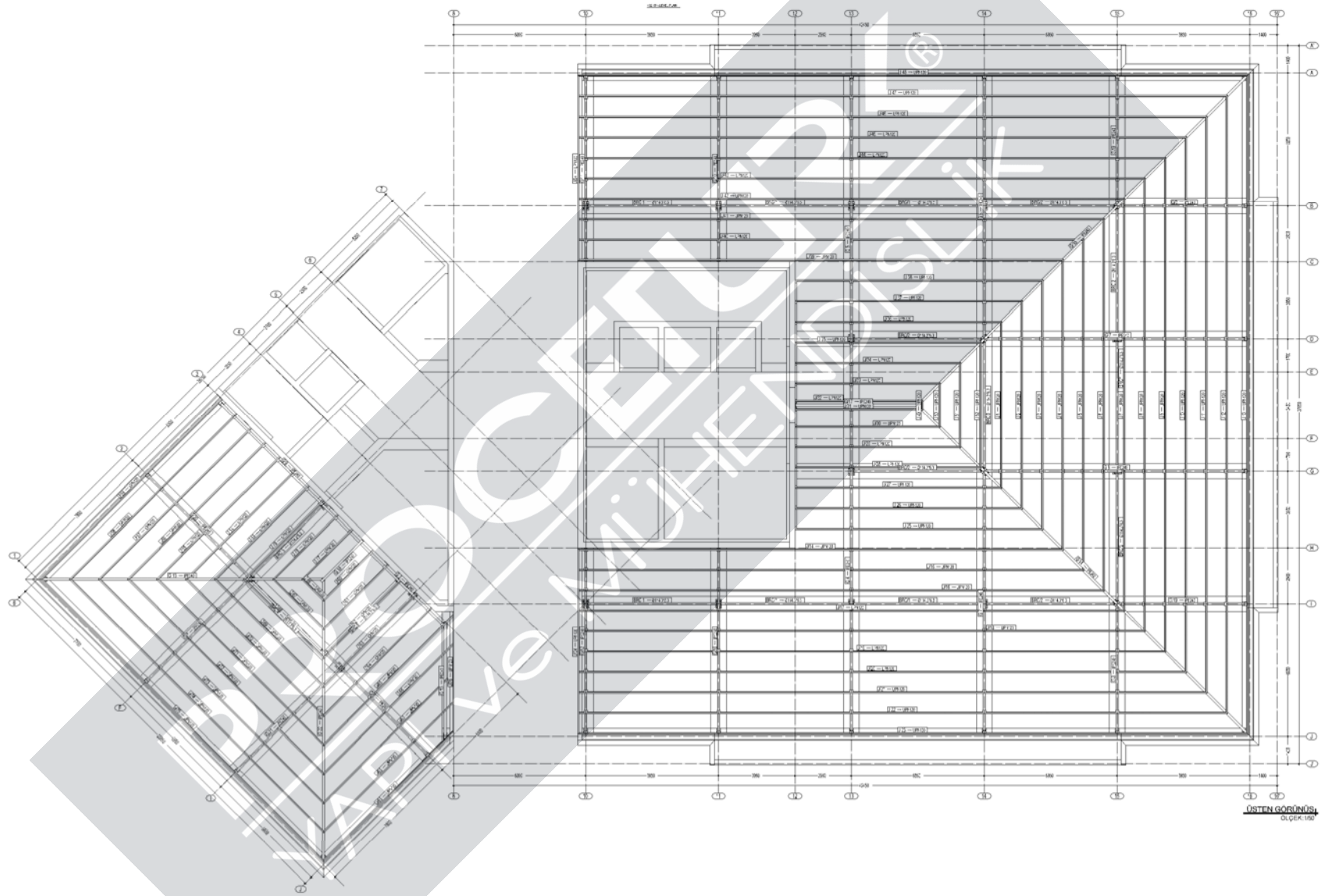

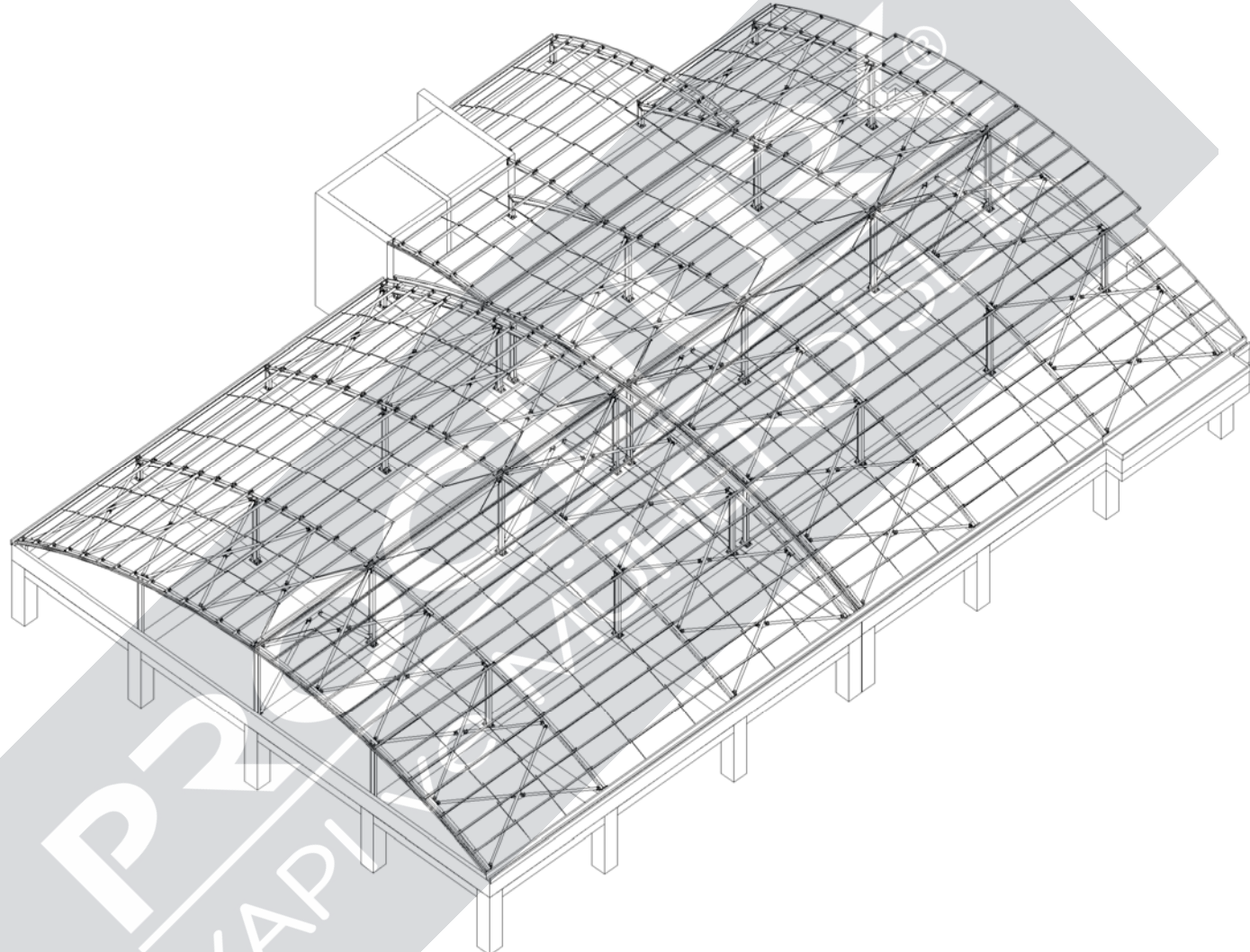

İZOMETRİK GÖRÜNÜŞ-1
ÖLÇEK: 1/50

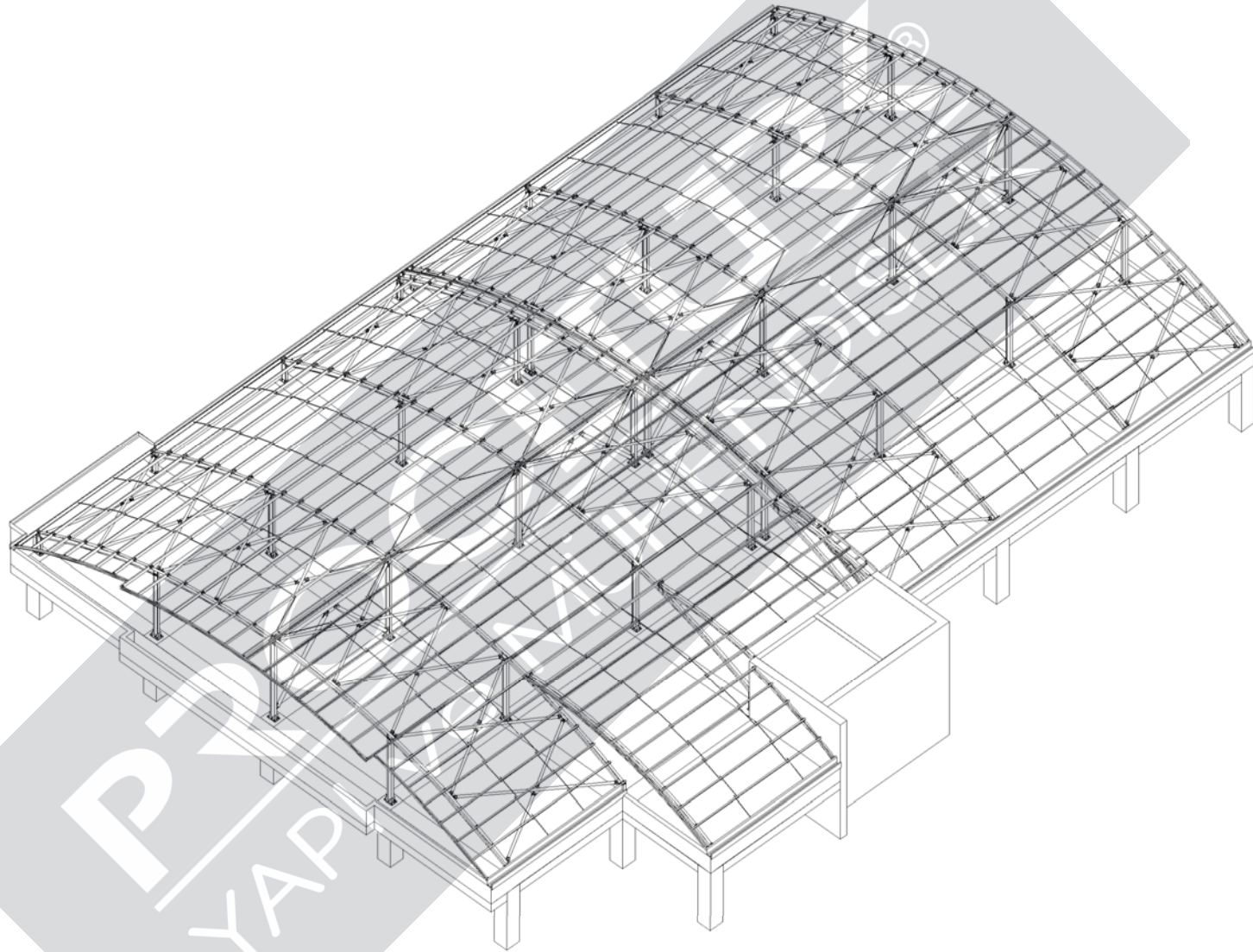

İZOMETRİK GÖRÜNÜŞ 2
01.07.2018

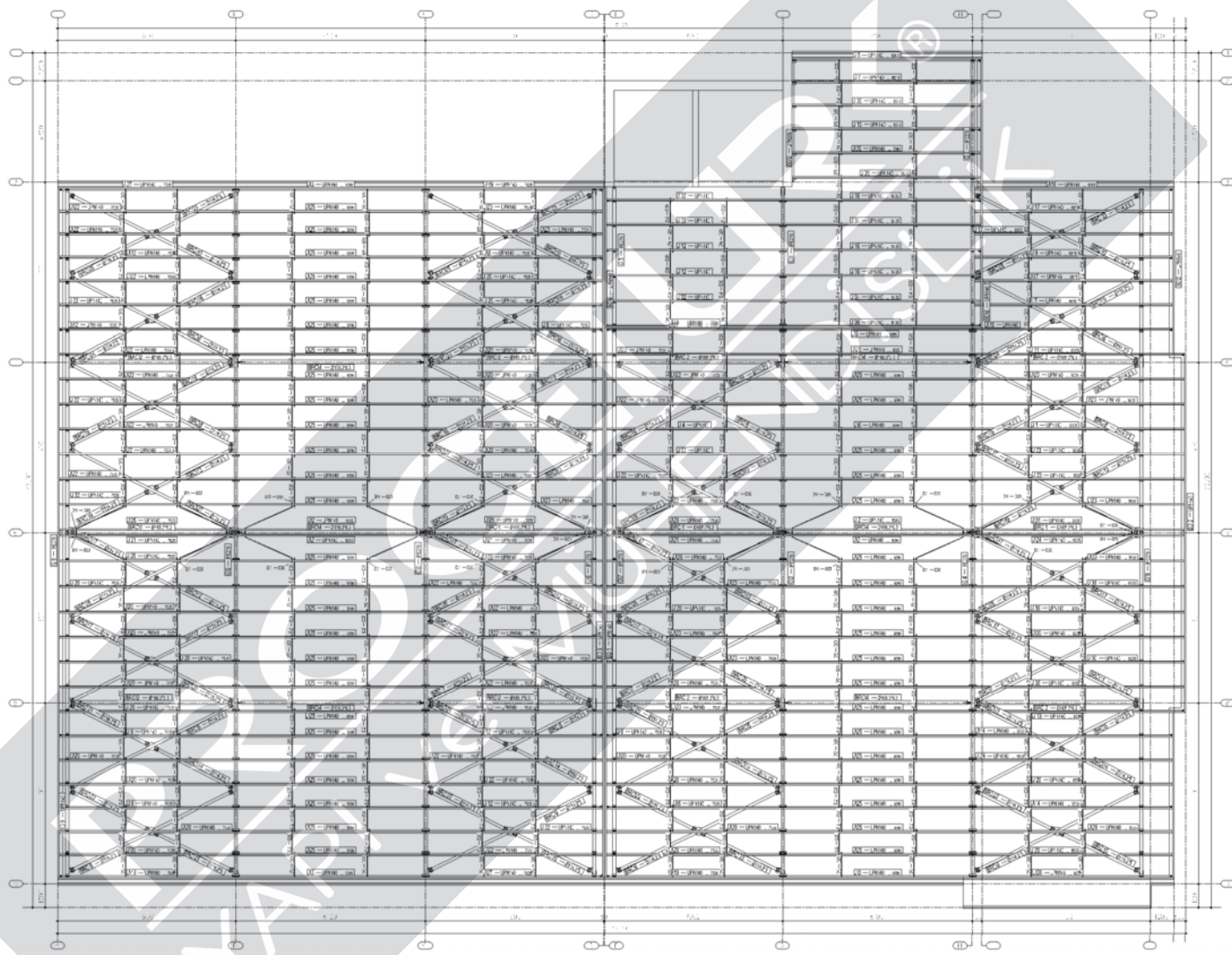

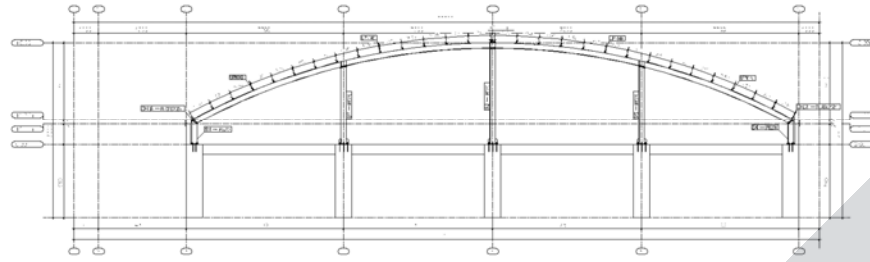

A-A AKS GÖRÜNÜŞÜ
ÖLÇEK 1/50

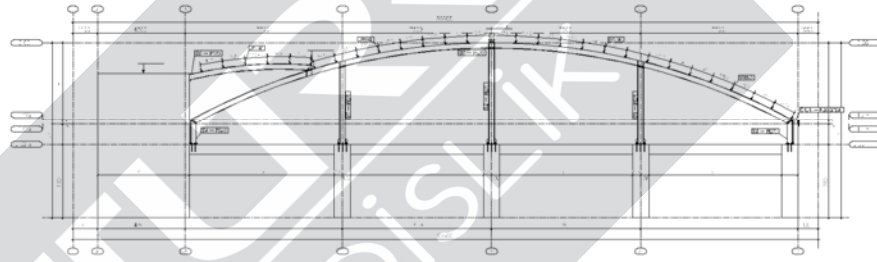

E-E AKS GÖRÜNÜŞÜ
ÖLÇEK 1/50

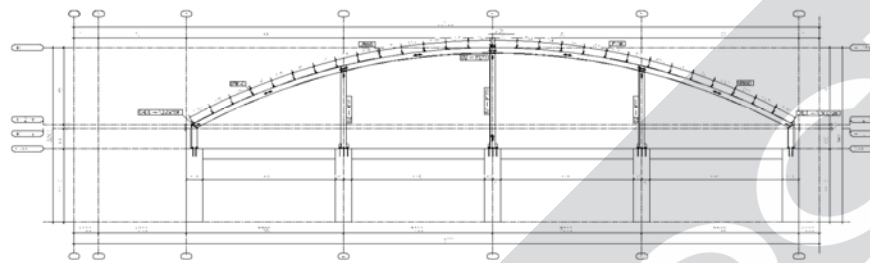

B-B AKS GÖRÜNÜŞÜ
ÖLÇEK 1/50

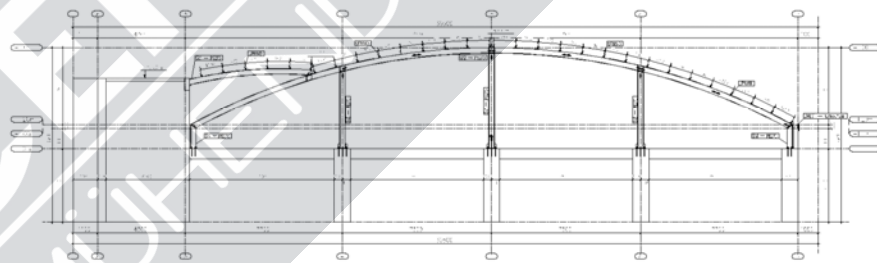

G-G AKS GÖRÜNÜŞÜ
ÖLÇEK 1/50

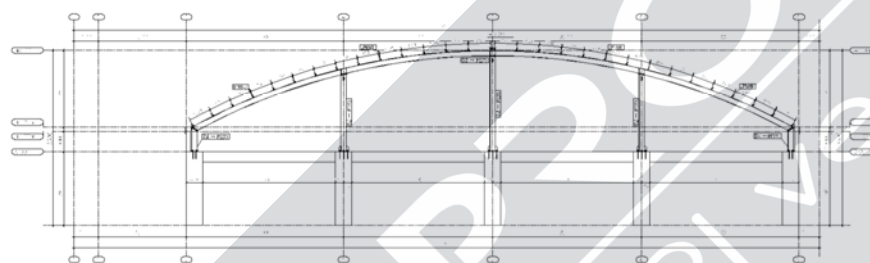

C-C AKS GÖRÜNÜŞÜ
ÖLÇEK 1/50

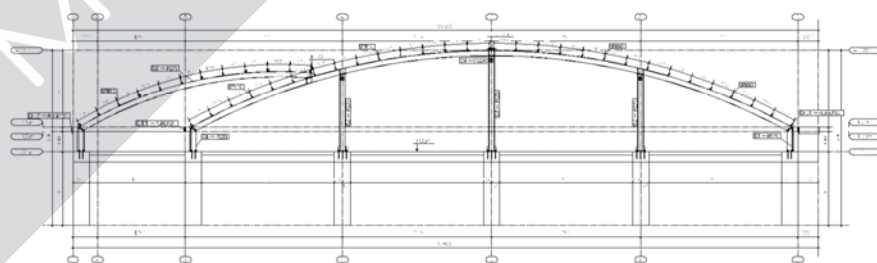

H-H AKS GÖRÜNÜŞÜ
ÖLÇEK 1/50

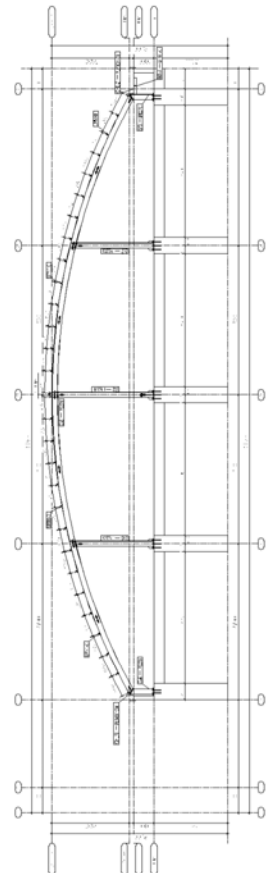

J-J AKS GÖRÜNÜŞÜ

YAPILAR MÜHÜR DİŞLİK

®

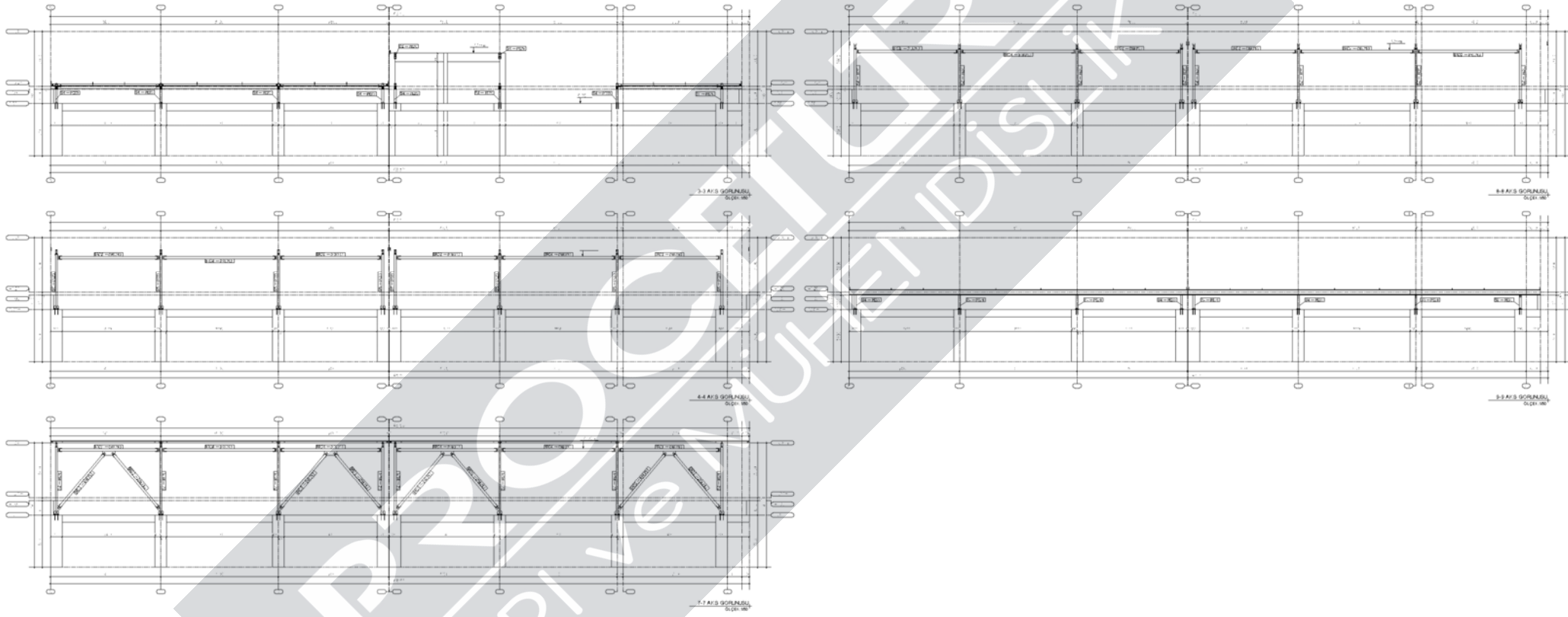

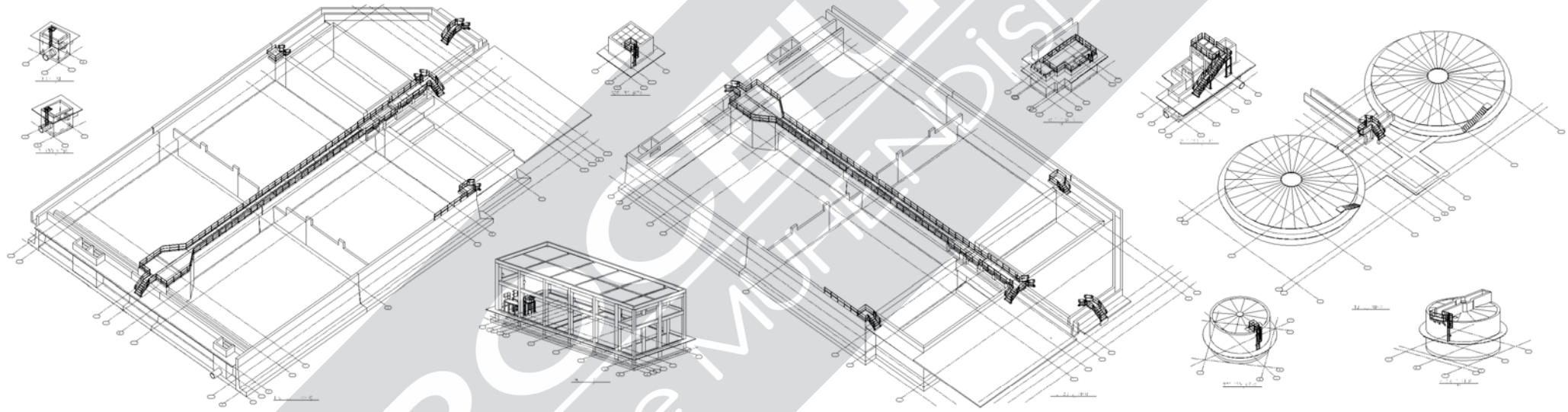

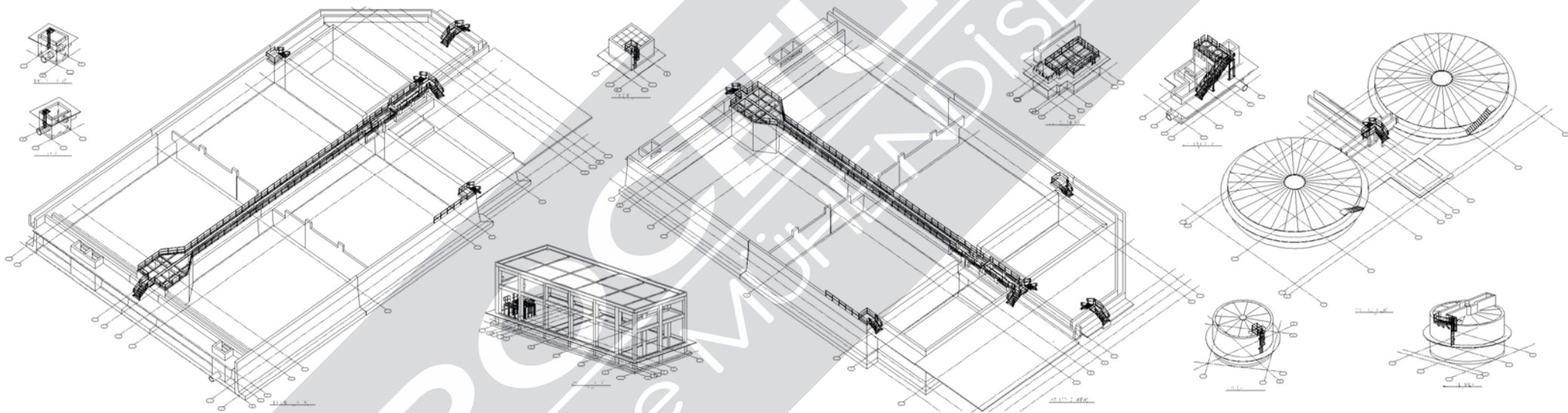

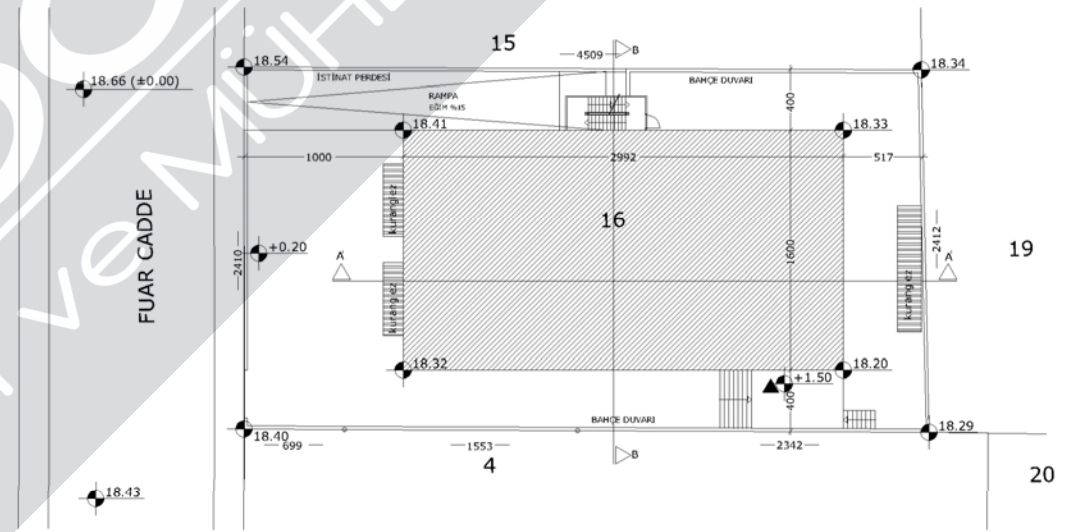
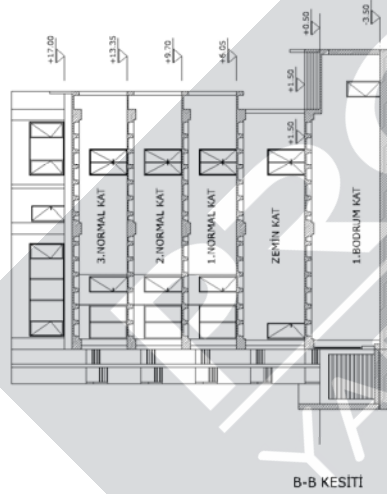
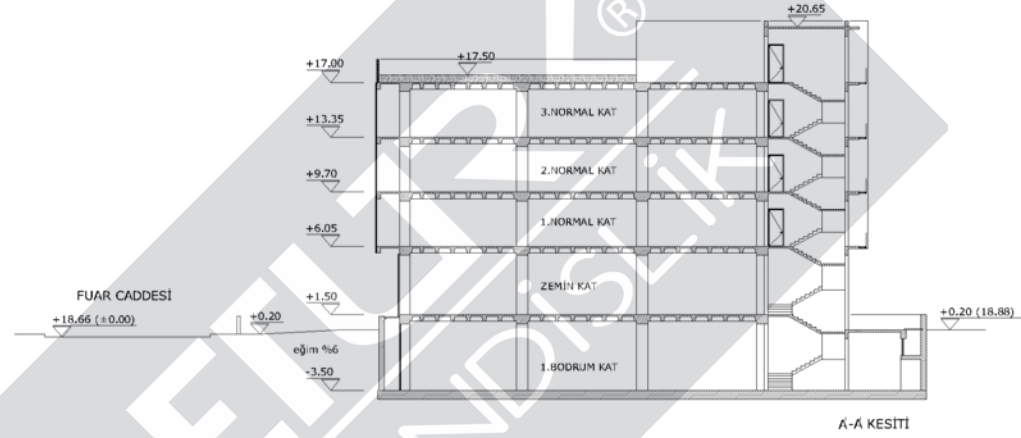

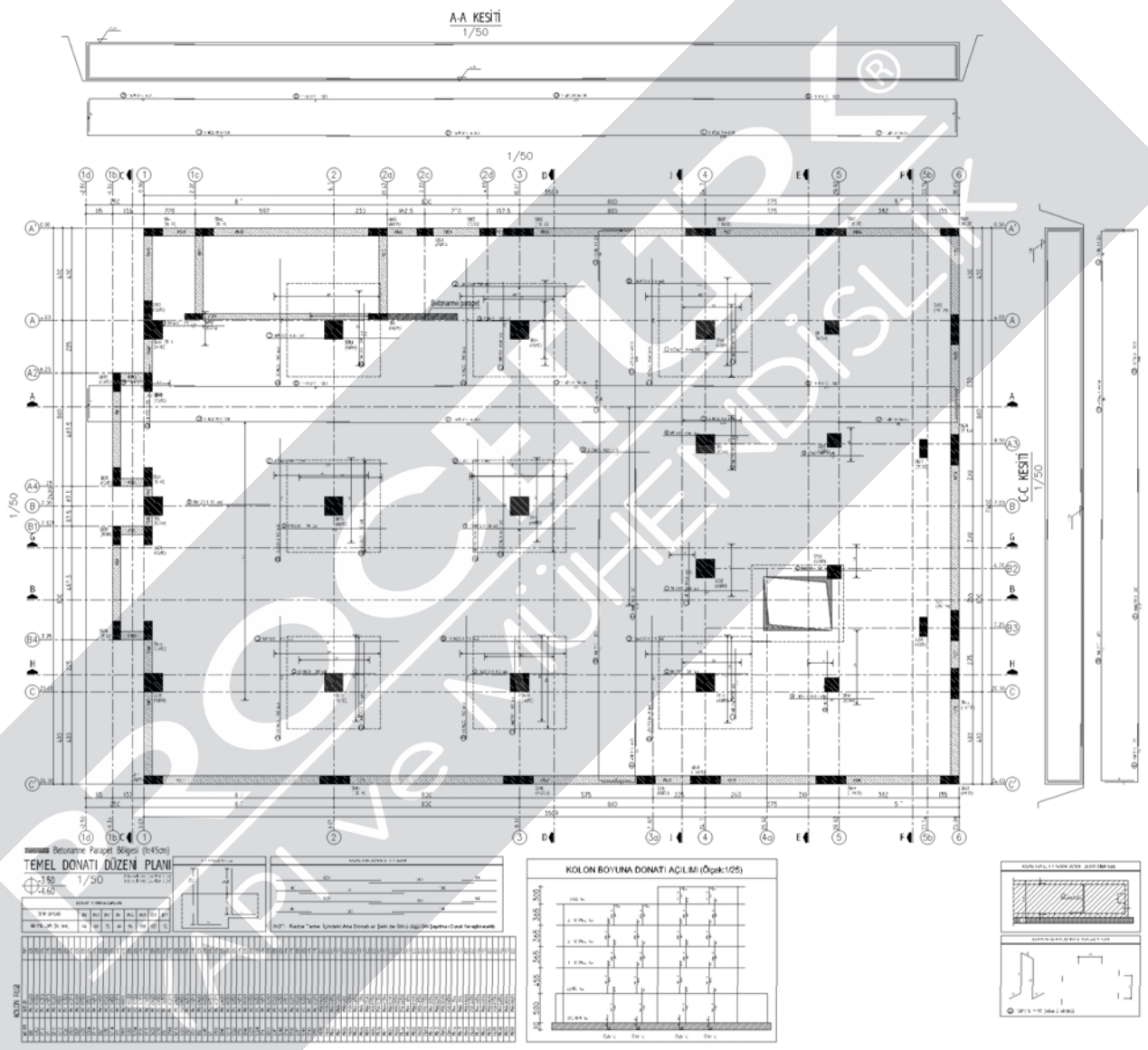

DETAYLAMA PARAFETİ RİJESİ (B-45cm)
TEMEL DONATI DÜZEN PLANI
 Ölçek: 1/50

YER	NO	AN	AN	AN	AN	AN	AN	AN	AN
1	1	1	1	1	1	1	1	1	1
2	2	2	2	2	2	2	2	2	2
3	3	3	3	3	3	3	3	3	3
4	4	4	4	4	4	4	4	4	4
5	5	5	5	5	5	5	5	5	5
6	6	6	6	6	6	6	6	6	6
7	7	7	7	7	7	7	7	7	7
8	8	8	8	8	8	8	8	8	8
9	9	9	9	9	9	9	9	9	9
10	10	10	10	10	10	10	10	10	10
11	11	11	11	11	11	11	11	11	11
12	12	12	12	12	12	12	12	12	12
13	13	13	13	13	13	13	13	13	13
14	14	14	14	14	14	14	14	14	14
15	15	15	15	15	15	15	15	15	15
16	16	16	16	16	16	16	16	16	16
17	17	17	17	17	17	17	17	17	17
18	18	18	18	18	18	18	18	18	18
19	19	19	19	19	19	19	19	19	19
20	20	20	20	20	20	20	20	20	20
21	21	21	21	21	21	21	21	21	21
22	22	22	22	22	22	22	22	22	22
23	23	23	23	23	23	23	23	23	23
24	24	24	24	24	24	24	24	24	24
25	25	25	25	25	25	25	25	25	25
26	26	26	26	26	26	26	26	26	26
27	27	27	27	27	27	27	27	27	27
28	28	28	28	28	28	28	28	28	28
29	29	29	29	29	29	29	29	29	29
30	30	30	30	30	30	30	30	30	30
31	31	31	31	31	31	31	31	31	31
32	32	32	32	32	32	32	32	32	32
33	33	33	33	33	33	33	33	33	33
34	34	34	34	34	34	34	34	34	34
35	35	35	35	35	35	35	35	35	35
36	36	36	36	36	36	36	36	36	36
37	37	37	37	37	37	37	37	37	37
38	38	38	38	38	38	38	38	38	38
39	39	39	39	39	39	39	39	39	39
40	40	40	40	40	40	40	40	40	40
41	41	41	41	41	41	41	41	41	41
42	42	42	42	42	42	42	42	42	42
43	43	43	43	43	43	43	43	43	43
44	44	44	44	44	44	44	44	44	44
45	45	45	45	45	45	45	45	45	45
46	46	46	46	46	46	46	46	46	46
47	47	47	47	47	47	47	47	47	47
48	48	48	48	48	48	48	48	48	48
49	49	49	49	49	49	49	49	49	49
50	50	50	50	50	50	50	50	50	50
51	51	51	51	51	51	51	51	51	51
52	52	52	52	52	52	52	52	52	52
53	53	53	53	53	53	53	53	53	53
54	54	54	54	54	54	54	54	54	54
55	55	55	55	55	55	55	55	55	55
56	56	56	56	56	56	56	56	56	56
57	57	57	57	57	57	57	57	57	57
58	58	58	58	58	58	58	58	58	58
59	59	59	59	59	59	59	59	59	59
60	60	60	60	60	60	60	60	60	60
61	61	61	61	61	61	61	61	61	61
62	62	62	62	62	62	62	62	62	62
63	63	63	63	63	63	63	63	63	63
64	64	64	64	64	64	64	64	64	64
65	65	65	65	65	65	65	65	65	65
66	66	66	66	66	66	66	66	66	66
67	67	67	67	67	67	67	67	67	67
68	68	68	68	68	68	68	68	68	68
69	69	69	69	69	69	69	69	69	69
70	70	70	70	70	70	70	70	70	70
71	71	71	71	71	71	71	71	71	71
72	72	72	72	72	72	72	72	72	72
73	73	73	73	73	73	73	73	73	73
74	74	74	74	74	74	74	74	74	74
75	75	75	75	75	75	75	75	75	75
76	76	76	76	76	76	76	76	76	76
77	77	77	77	77	77	77	77	77	77
78	78	78	78	78	78	78	78	78	78
79	79	79	79	79	79	79	79	79	79
80	80	80	80	80	80	80	80	80	80
81	81	81	81	81	81	81	81	81	81
82	82	82	82	82	82	82	82	82	82
83	83	83	83	83	83	83	83	83	83
84	84	84	84	84	84	84	84	84	84
85	85	85	85	85	85	85	85	85	85
86	86	86	86	86	86	86	86	86	86
87	87	87	87	87	87	87	87	87	87
88	88	88	88	88	88	88	88	88	88
89	89	89	89	89	89	89	89	89	89
90	90	90	90	90	90	90	90	90	90
91	91	91	91	91	91	91	91	91	91
92	92	92	92	92	92	92	92	92	92
93	93	93	93	93	93	93	93	93	93
94	94	94	94	94	94	94	94	94	94
95	95	95	95	95	95	95	95	95	95
96	96	96	96	96	96	96	96	96	96
97	97	97	97	97	97	97	97	97	97
98	98	98	98	98	98	98	98	98	98
99	99	99	99	99	99	99	99	99	99
100	100	100	100	100	100	100	100	100	100

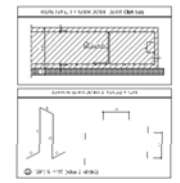
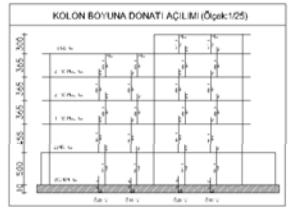

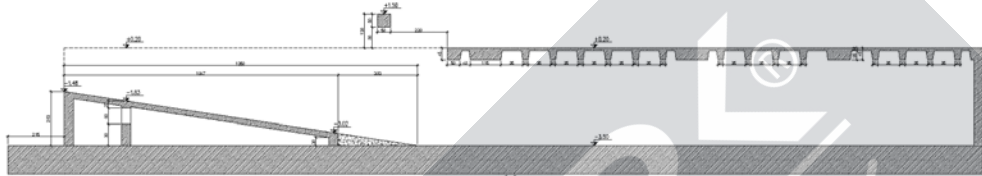

A-A KESİTİ
1/50



B-B KESİTİ
1/50

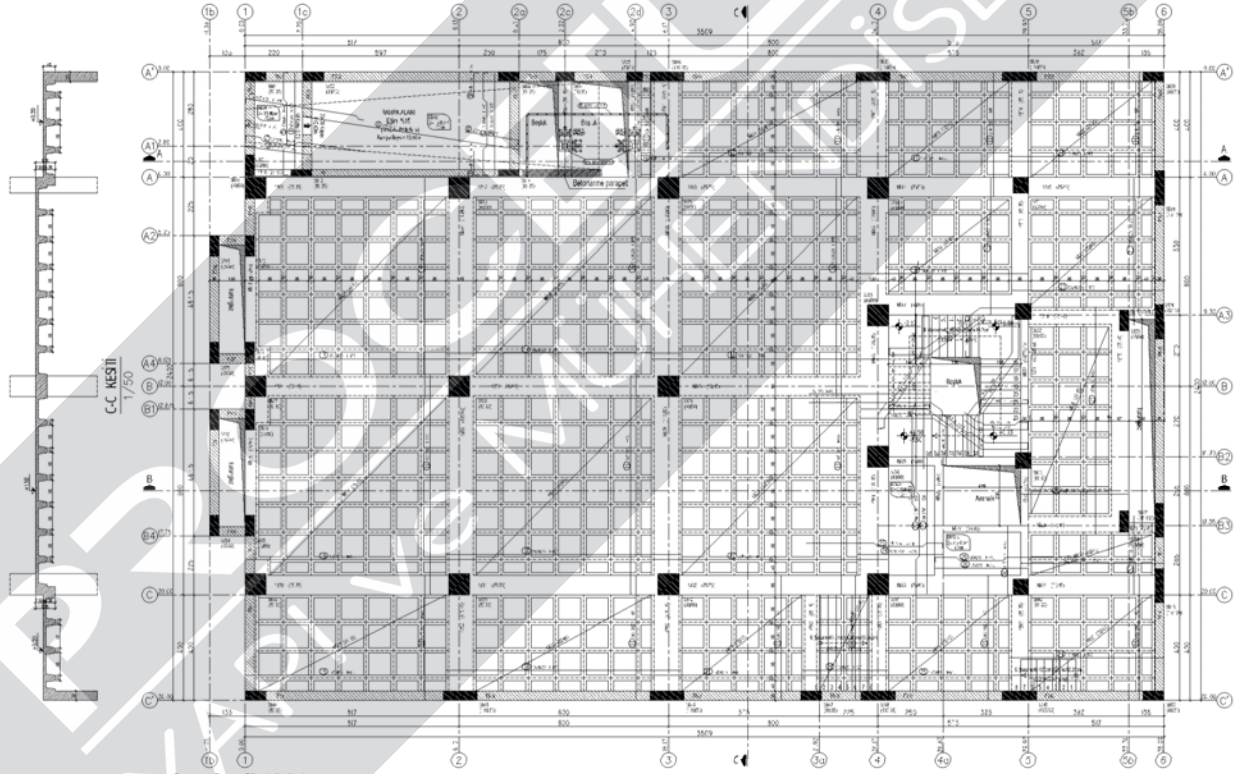

Detaylar: Farapıt Bölgesi (1/45cm)
BODRUM KAT KALIP PLANI
 +1.50 / -1.50 1/50

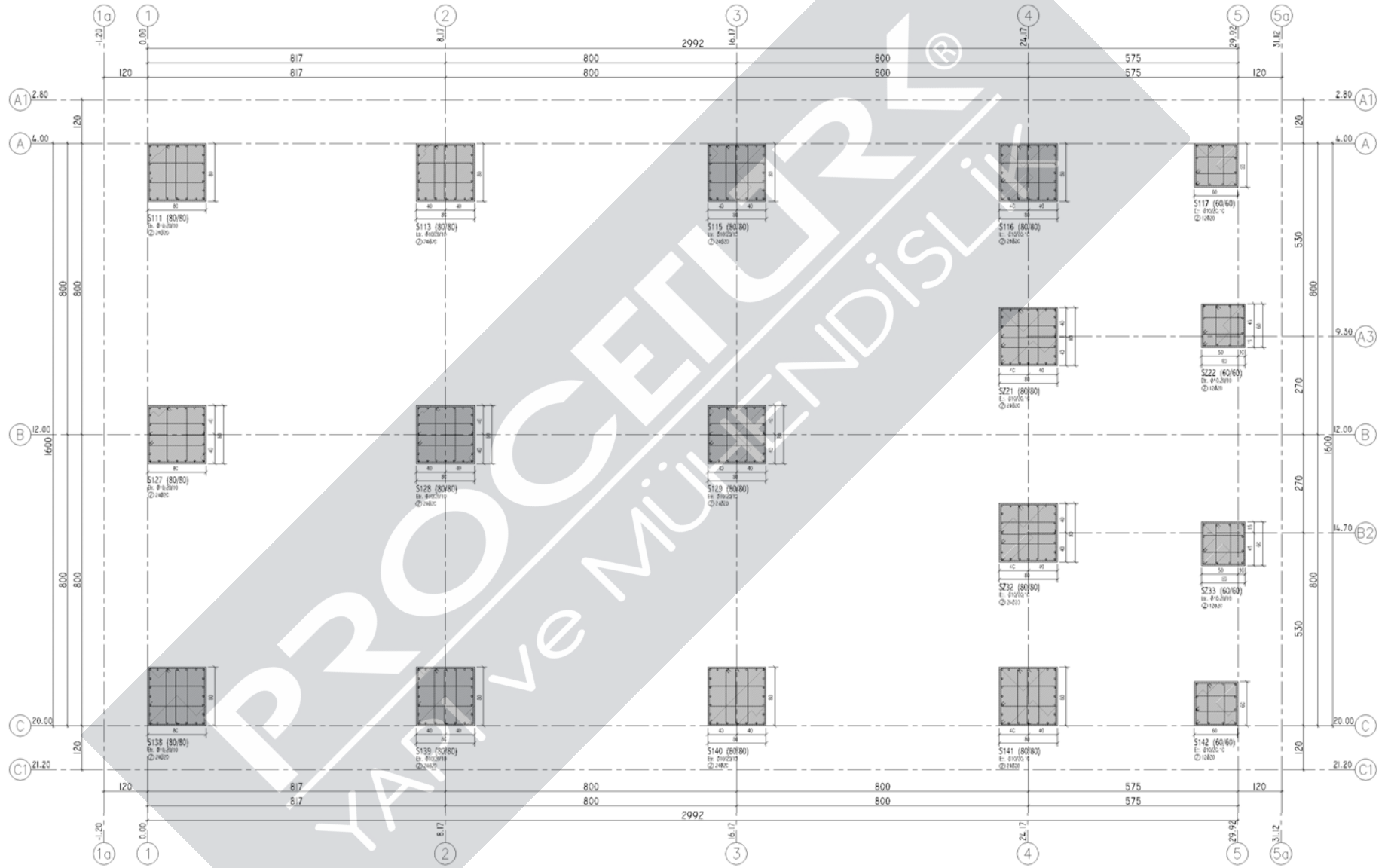

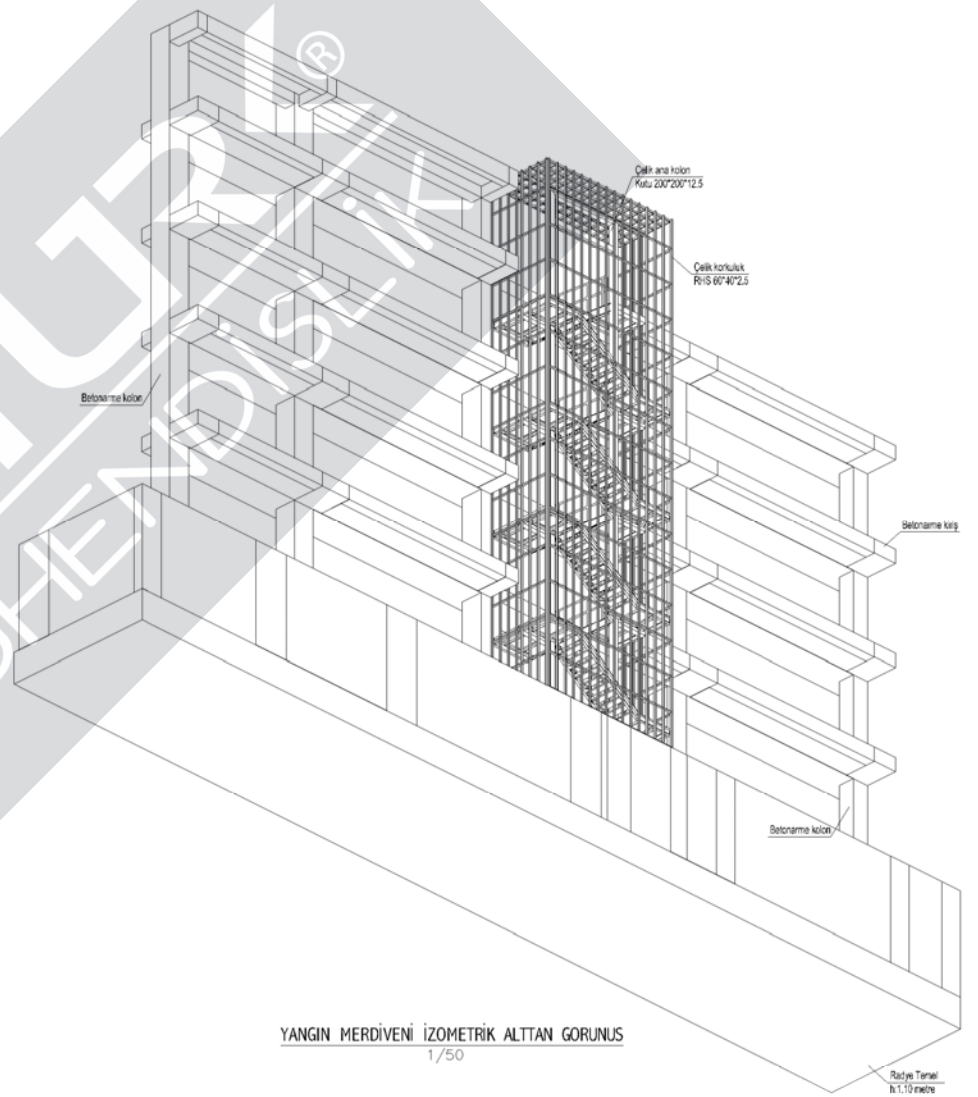
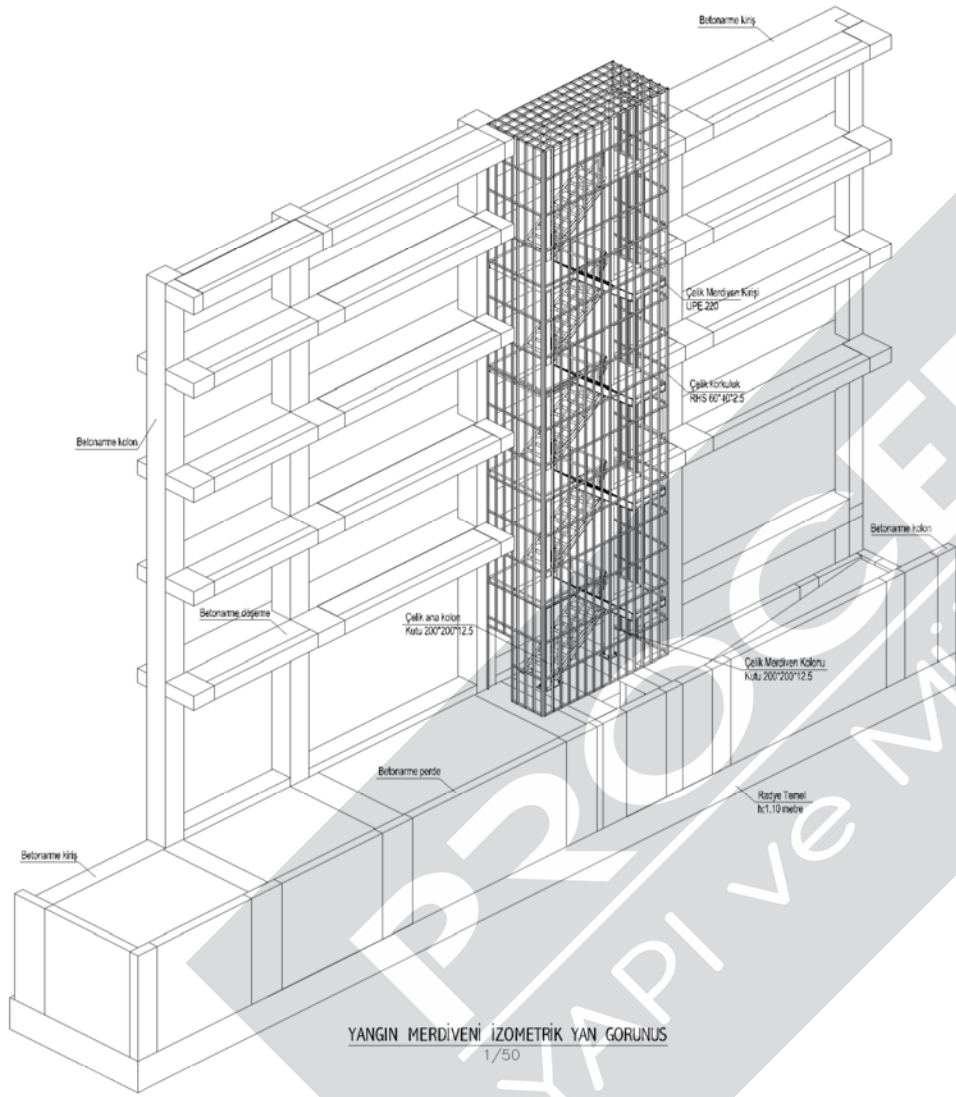

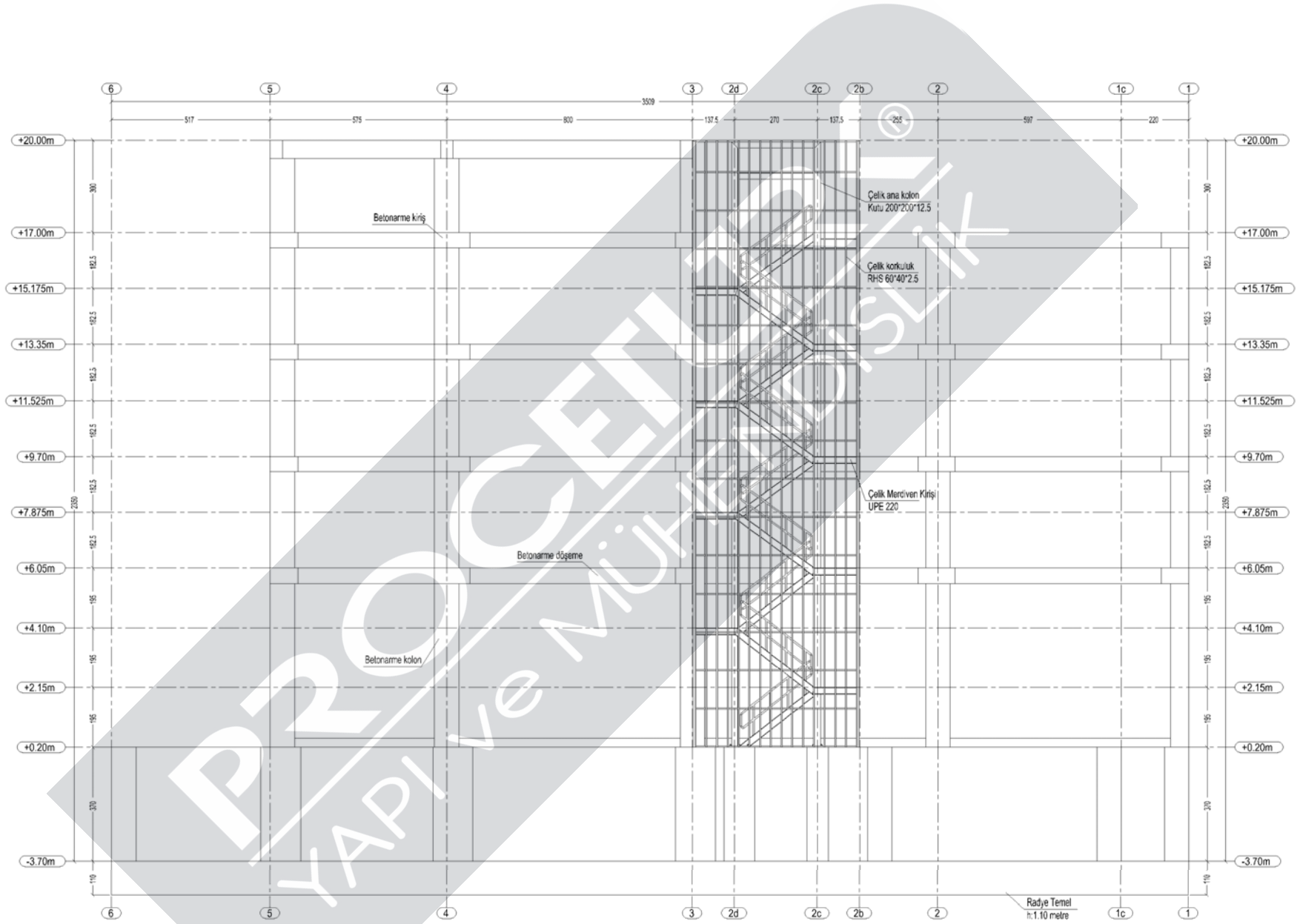

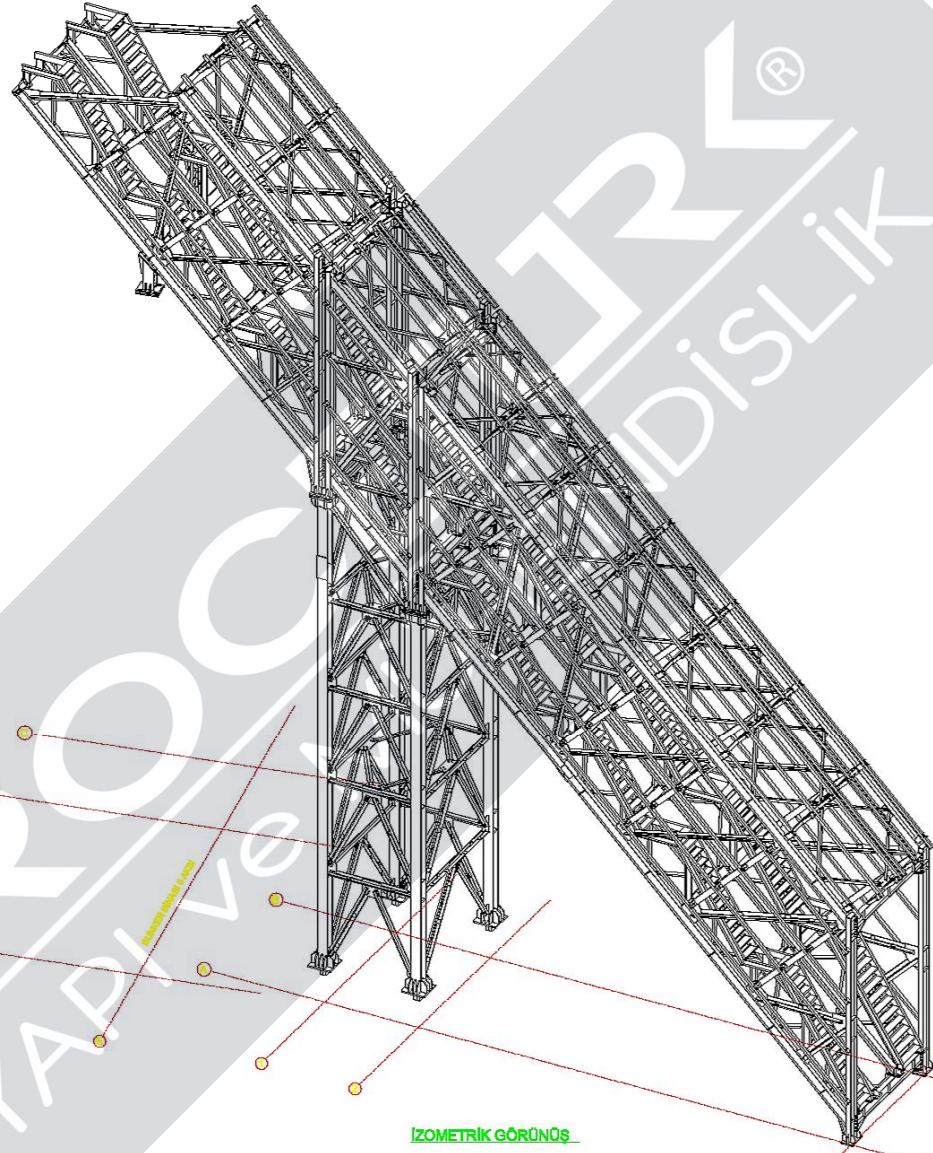

İZOMETRİK GÖRÜNÜŞ

PROOC®
YAPILVE
DISLIK

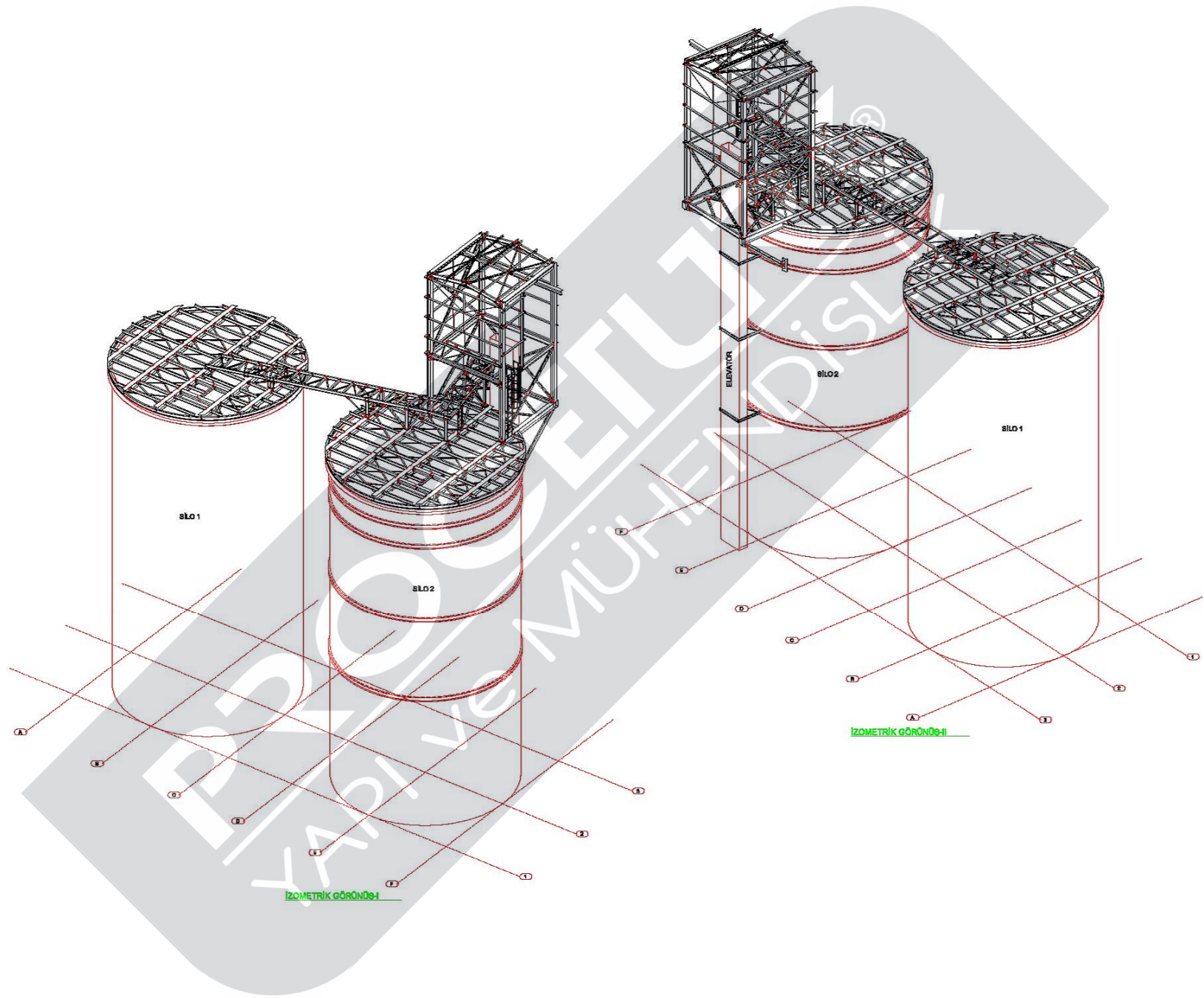

İZOMETRİK GÖRÜNÜŞ-I

İZOMETRİK GÖRÜNÜŞ-II

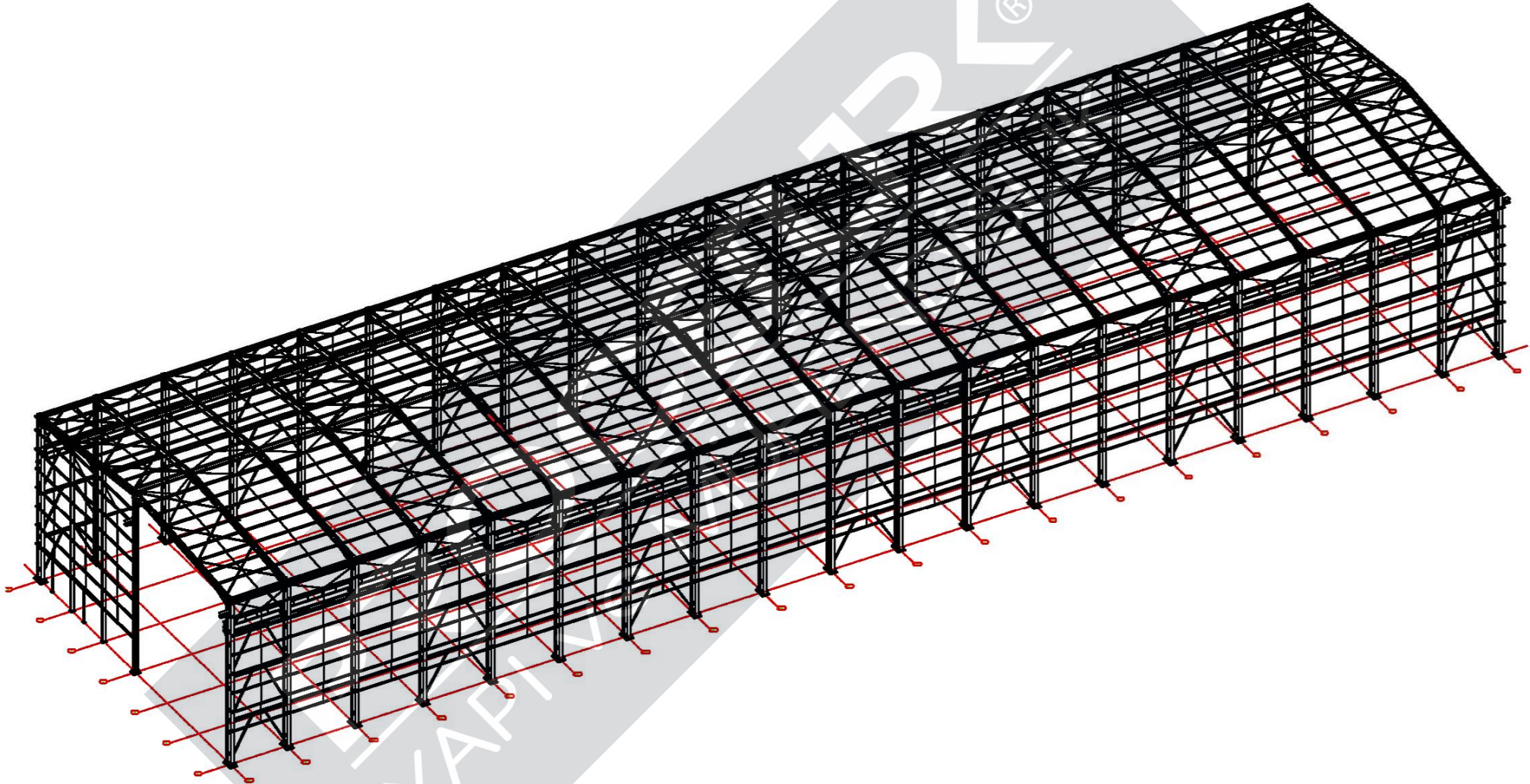

TRL®
YAPILAR

